

2025



Hakkımızda

1943 yılında Zeki Özdemir tarafından Radyo Emek Atölyesi olarak başlanan ticari yaşam, Zeki Özdemir Ticarethanesi olarak devam etmiş,1963 yılında Zeki-Eray Özdemir olarak Elmak Dahili Ticaret Mümessilik-İthalat bünyesinde gelişimini Arçelik Beyaz Eşya Bayiliđini’de katarak sürdürmüştür.1998 yılında gelindiğinde sermaye şirketine dönüştürülerek “Konya Elmak Elektrik A.Ş.” adını almıştır

Şu anda Elektrik endüstrisinde 80 yılını aşkın deneyime sahip bir şirket olan Kontya Elmak Elektrik A.Ş.’nin 4. Kuşağı olarak sizlere hoşgeldiniz diyoruz.

Konya Elmak Elektrik Ticaret ve Sanayi A.Ş. 80 yılı aşkın süredir Türkiyenin dört bir yanındaki müşterilerine en kaliteli elektrik ürünlerini temin etmektedir.

Mükemmelliđe ve müşteri memnuniyetine olan bağlılığımız bizi sektörde öne çıkararak en güvenilir isimlerden biri yapmıştır. Konya Elmak A.Ş. ailesi olarak, elektrik endüstrisinde güvenilirlik ve performansın önemini anlıyoruz.

Bu nedenle yalnızca endüstri standartlarını karşılayan ürünleri ithal ediyoruz ve sektördeki en saygın tedarikçişer tarafından üretilen ürünleri sunuyoruz.

Geniş ürün yelpazemiz birçok endüstriyel ürünü kapsıyor ve teknolojik gelişmelere ayak uydurmak için envanterimizi sürekli güncelliyoruz.

Konusunda uzman ve tecrübeli çalışanlarımızız, sorularınızı yanıtlamak ve en iyi ürünleri tedarik konusunda yardımcı olmak için her zaman hazırız.

Konya Elmak A.Ş. , müşterilerine sorun yaşatmadan pazarlama faaliyetlerini ve malzeme teminini yürütmekte, sahip olduđu zengin ürün kapasitesi, gelişime, yenilenmeye açık politikamız ile tüm Türkiye çapında hizmetimizi sürdürerek elektrik sektöründe yerini güçlü bir şekilde almıştır.

Saygılarımızla.

www.el-max.com.tr

XCK Plastik Gövdeli Limit Switch	5-7
CSA Metal Gövdeli Limit Switch	8
Mini Switch	9
Mikro Switch	10
Kumanda Kutuları	11 - 18
LAY 5 Plastik Buton Serisi	20 - 21
LAY 5 Metal Buton-Joystick ve Potansiyometre	22 - 23
2M Buton Serisi	24 - 26
İzoleli Kablo Yüksük	27
İzoleli Pabuç	28 - 29
Terminal	30 - 31
Ledli Sinyal - Buzzer -Siren	32
Ampermetre - Voltmetre	33
SKP Kablo Pabuçları - Ek Mufları	34 - 35

36	Bi-metal SKP Kablo Pabucu
37	Bi-Metal Uzun Tip
37	Bi-Metal Ek Muf Pinli
38	Bi-Metal Ek Muf
39	Pano Topraklama Klemensler
40 - 41	Dağıtım Üniteleri
42	Geçmeli Buat Klemensler
42	Çok Amaçlı Klemensler Tırnaklı
43	Plastik Kablo Bağları
44 - 45	Ayak Pedalları-Vinç Kumanda Butonları
47	24 Volt Kontaktör
47	UNMC Serisi Kontaktörler
48	D Serisi Kontaktörler
48 - 49	Yardımcı Kontak Blokları
49	Sessiz Kontaktör ve Darbe Akım Anahtarı
50	Termik Röleler
52 - 64	Asansör Grubu Ürünleri

XCK Plastik Gövdeli Limit Switch



XCK-SUM 211



XCK-SUM 331



XCK-SUM 332RS



XCK-SİM 311



XCK-SİM 411



XCK-SEM 121



XCK-SEM 122



XCK-SEL 123R



XCK-SOM 102

Tüm Özellikleriyle
ÇOK ÖZEL

XCK Plastik Gövdeli Limit Switch Özellikleri

- Estetik plastik gövde • Paslanmaz makara ve kol • Yüksek mekanik dayanıklılık • Ekstra geniş $\pm 95^\circ$ hareketli, • PG 13.5 kablo rekoru kullanılabilir • Kompakt gövde • 1NO/1NC 2 anahtarlama kontak • Hareketli çift kontaklar • PG 13.5/M20x1.5 kablo rakoru girişli • IP67
- Tüm modellerde tahrik kafa contası • Gövde vidası M3+Somon sıkmalı • Kontak bloğunu çıkartarak dışarda rahat bağlantı olanađı • Gövde kapak vidası kapak üzerinden düşmez • Uluslararası gövde standartlarında.

XCK-SUM 211

XCK Plastik Gövdeli
Limit Switch

FİYAT: 5,98 \$



ÜRÜN KODU	XCK-SUM 211 (CLS101)
KONTAK TİPİ	1NO+1NC
AÇIKLAMA	Doğrusal Hareketli Metal Pim
KUTU ADEDİ	10 Adet

XCK-SUM 331

XCK Plastik Gövdeli
Limit Switch

FİYAT: 5,67 \$



ÜRÜN KODU	XCK-SUM 331 (CLS103)
KONTAK TİPİ	1NO+1NC
AÇIKLAMA	Doğrusal Hareketli 11mm Metal Makaralı Pim
KUTU ADEDİ	10 Adet

XCK-SUM 332RS

XCK Plastik Gövdeli
Limit Switch

FİYAT: 5,67 \$



ÜRÜN KODU	XCK-SUM 332RS (CLS103R)
KONTAK TİPİ	1NO+1NC
AÇIKLAMA	Doğrusal Hareketli Resetli 11mm Metal Makaralı Pim
KUTU ADEDİ	10 Adet

Üst kapak vidası M3 kapaktan düşmez. Kontak blođu çıkarılabilir. Rahatlıkla kablo bağlanır.

XCK Plastik Gövdeli Limit Switch

XCK-SİM 311

XCK Plastik Gövdeli
Limit Switch

FİYAT: 5,98 \$



ÜRÜN KODU	XCK-SİM 311 (CLS111)
KONTAK TİPİ	1NO+1NC
AÇIKLAMA	Açısal Hareketli 14 mm Metal Makaralı Kol
KUTU ADEDİ	10 Adet

XCK-SİM 411

XCK Plastik Gövdeli
Limit Switch

FİYAT: 5,98 \$



ÜRÜN KODU	XCK-SİM 411 (CLS127)
KONTAK TİPİ	1NO+1NC
AÇIKLAMA	Açısal Hareketli Ters Açılı 14 mm Metal Makaralı Kol
KUTU ADEDİ	10 Adet

XCK-SEM 123

XCK Plastik Gövdeli
Limit Switch

FİYAT: 6,06 \$



ÜRÜN KODU	XCK-SEM 123 (CLS131M)
KONTAK TİPİ	1NO+1NC
AÇIKLAMA	Açısal Hareketli Ayarlanabilir 18 mm Metal Makaralı Döner Uzun Kol
KUTU ADEDİ	10 Adet

XCK-SEM 121

XCK Plastik Gövdeli
Limit Switch

FİYAT: 5,98 \$



ÜRÜN KODU	XCK-SEM 121 (CLS121)
KONTAK TİPİ	1NO+1NC
AÇIKLAMA	Açısal Hareketli 18 mm Metal Makaralı Döner Kol
KUTU ADEDİ	10 Adet

XCK-SEM 122

XCK Plastik Gövdeli
Limit Switch

FİYAT: 6,06 \$



ÜRÜN KODU	XCK-SEM 122 (CLS131)
KONTAK TİPİ	1NO+1NC
AÇIKLAMA	Açısal Hareketli Ayarlanabilir 18 mm Metal Makaralı Döner Kol
KUTU ADEDİ	10 Adet

Üst kapak vidası M3 kapaktan düşmez. Kontak blođu çıkarılabilir. Rahatlıkla kablo bağlanır.

XCK Plastik Gövdeli Limit Switch

XCK-SEL 123

XCK Plastik Gövdeli
Limit Switch

FİYAT: 5,67 \$



ÜRÜN KODU	XCK-SEL 123 (CLS191)
KONTAK TİPİ	1NO+1NC
AÇIKLAMA	Açısal Hareketli Ayarlanabilir 50 mm Lastik Makaralı Döner Kol
KUTU ADEDİ	10 Adet

XCK-SEL 123R

XCK Plastik Gövdeli
Limit Switch

FİYAT: 7,22 \$



ÜRÜN KODU	XCK-SEL 123 R (CLS191R)
KONTAK TİPİ	1NO+1NC
AÇIKLAMA	Açısal Hareketli Ayarlanabilir 50 mm Lastik Makaralı Resetli Döner Kol
KUTU ADEDİ	10 Adet

XCK-SOM 101

XCK Plastik Gövdeli
Limit Switch

FİYAT: 6,29 \$



ÜRÜN KODU	XCK-SOM 101 (CLS161)
KONTAK TİPİ	1NO+1NC
AÇIKLAMA	Açısal Hareketli Spiral Telli Çok Yönlü Kol
KUTU ADEDİ	10 Adet

XCK-SOM 102

XCK Plastik Gövdeli
Limit Switch

FİYAT: 6,29 \$



ÜRÜN KODU	XCK-SOM 102 (CLS181)
KONTAK TİPİ	1NO+1NC
AÇIKLAMA	Açısal Hareketli Metal Uçlu Metal Spiral Çok Yönlü Kol
KUTU ADEDİ	10 Adet

Yanmaz, kırılmaz özel plastik gövde kollu ürünlerde 5° - 90° hassas ayar olanađı, uzun kol mesafesi

CSA Metal Gvdeli Limit Switch
CSA 001
CSA METAL
GVDELİ LİMİT
SWITCH

FİYAT: 15,30 \$

RN KODU	CSA-001
KONTAK TİPİ	1NO+1NC
AIKLAMA	Dikey Buton Tahrikli Dođrusal Pim
KUTU ADEDİ	10 Adet

CSA 003
CSA METAL
GVDELİ LİMİT
SWITCH

FİYAT: 15,30 \$

RN KODU	CSA-003
KONTAK TİPİ	1NO+1NC
AIKLAMA	Dikey Metal Makara Tahrikli Dođrusal Makaralı Pim
KUTU ADEDİ	10 Adet

CSA 004
CSA METAL
GVDELİ LİMİT
SWITCH

FİYAT: 15,30 \$



RN KODU	CSA-004
KONTAK TİPİ	1NO+1NC
AIKLAMA	Dikey Ters Metal Makara Tahrikli
KUTU ADEDİ	10 Adet

CSA 021
CSA METAL
GVDELİ LİMİT
SWITCH

FİYAT: 15,30 \$

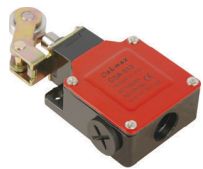

RN KODU	CSA-021
KONTAK TİPİ	1NO+1NC
AIKLAMA	Aısal Kol Makaralı
KUTU ADEDİ	10 Adet

CSA 012
CSA METAL
GVDELİ LİMİT
SWITCH

FİYAT: 15,30 \$

RN KODU	CSA-012
KONTAK TİPİ	1NO+1NC
AIKLAMA	Dođrusal Pim Kol Makara
KUTU ADEDİ	10 Adet

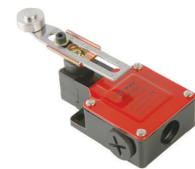
CSA 031
CSA METAL
GVDELİ LİMİT
SWITCH

FİYAT: 15,30 \$

RN KODU	CSA-031
KONTAK TİPİ	1NO+1NC
AIKLAMA	Ø 18mm Ayarlanabilir Sađ-Sol Metal Kol Makara Tahrikli
KUTU ADEDİ	10 Adet

CSA 061
CSA METAL
GVDELİ LİMİT
SWITCH

FİYAT: 15,30 \$

RN KODU	CSA-061
KONTAK TİPİ	1NO+1NC
AIKLAMA	Spiral Metal Tel Tahrikli
KUTU ADEDİ	10 Adet

CSA 071
CSA METAL
GVDELİ LİMİT
SWITCH

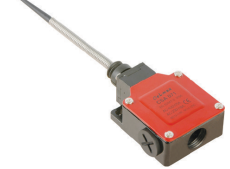
FİYAT: 15,30 \$

RN KODU	CSA-071
KONTAK TİPİ	1NO+1NC
AIKLAMA	Spiral Plastik ubuklu Yay Tahrikli
KUTU ADEDİ	10 Adet

st kapak vidası M3 kapaktan dşmez. Kontak blođu ıkarılabilir. Rahatlıkla kablo bađlanır.

Mini Switch (Silver Contact)

XZ-15GQ-B

Mini Switch
(Silver Contact) / 15 Amper

FİYAT: 3,35 \$



ÜRÜN KODU	XZ-15GQ-B (CM1307)
KONTAK TİPİ	1NO+1NC
AÇIKLAMA	Kalın Uzun Pimil
AMPER	15 A
KUTU ADEDİ	20 Adet

XZ-15GQ22-B

Mini Switch
(Silver Contact) / 15 Amper

FİYAT: 3,60 \$



ÜRÜN KODU	XZ-15GQ22-B (CM1308)
KONTAK TİPİ	1NO+1NC
AÇIKLAMA	Dik Metal Makaralı Pin
AMPER	15 A
KUTU ADEDİ	20 Adet

XZ-15GQ21-B

Mini Switch
(Silver Contact) / 15 Amper

FİYAT: 3,60 \$



ÜRÜN KODU	XZ-15GQ21-B (CM1309)
KONTAK TİPİ	1NO+1NC
AÇIKLAMA	Dikey Metal Makara Pim
AMPER	15 A
KUTU ADEDİ	20 Adet

XZ-15GW2-B

Mini Switch
(Silver Contact) / 15 Amper

FİYAT: 3,33 \$

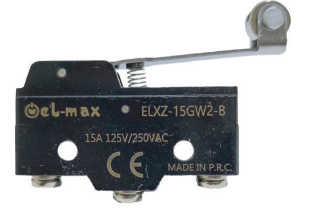

ÜRÜN KODU	XZ-15GW2-B (CM1703)
KONTAK TİPİ	1NO+1NC
AÇIKLAMA	Uzun Palet Metal Makaralı
AMPER	15 A
KUTU ADEDİ	20 Adet

XZ-15GW-B

Mini Switch
(Silver Contact) / 15 Amper

FİYAT: 3,33 \$

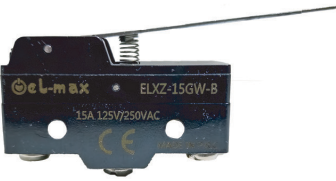

ÜRÜN KODU	XZ-15GW-B (CM1701)
KONTAK TİPİ	1NO+1NC
AÇIKLAMA	Uzun Palet
AMPER	15 A
KUTU ADEDİ	20 Adet

XZ-15GW22-B

Mini Switch
(Silver Contact) / 15 Amper

FİYAT: 3,05 \$



ÜRÜN KODU	XZ-15GW22-B (CM1704)
KONTAK TİPİ	1NO+1NC
AÇIKLAMA	Kısa Palet Metal Makaralı
AMPER	15 A
KUTU ADEDİ	20 Adet

XZ-15GW3-B

Mini Switch
(Silver Contact) / 15 Amper

FİYAT: 4,73 \$

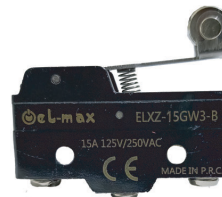

ÜRÜN KODU	XZ-15GW3-B
KONTAK TİPİ	1NO+1NC
AÇIKLAMA	Orta Palet Metal Makaralı
AMPER	15 A
KUTU ADEDİ	20 Adet

XAP-Y

Mini Switch Kapađı

FİYAT: 0,95 \$



ÜRÜN KODU	XAP-Y
AÇIKLAMA	Mini Siviç Koruma Kılıfı 45° Açılı Kauçuk
AMPER	15 A
KUTU ADEDİ	100 Adet

Mikro Switch (Silver Contact)

XV-15-1C25

 Mikro Switch
(Silver Contact) / 15 Amper

FİYAT: 1,19 \$

ÜRÜN KODU	XV-15-1C25
KONTAK TİPİ	1NO+1NC
AÇIKLAMA	Buton Tip Pimli
KUTU ADEDİ	100 Adet

XV-151-1C25

 Mikro Switch
(Silver Contact) / 15 Amper

FİYAT: 1,19 \$

ÜRÜN KODU	XV-151-1C25
KONTAK TİPİ	1NO+1NC
AÇIKLAMA	Kısa Palet
KUTU ADEDİ	100 Adet

XV-152-1C25

 Mikro Switch
(Silver Contact) / 15 Amper

FİYAT: 1,19 \$

ÜRÜN KODU	XV-152-1C25 Orta Palet
KONTAK TİPİ	1NO+1NC
AÇIKLAMA	Orta Palet
KUTU ADEDİ	100 Adet

XV-153-1C25

 Mikro Switch
(Silver Contact) /
15 Amper

FİYAT: 1,19 \$

ÜRÜN KODU	XV-153-1C25
KONTAK TİPİ	1NO+1NC
AÇIKLAMA	Uzun Palet
KUTU ADEDİ	100 Adet

XV-154-1C25

 Mikro Switch
(Silver Contact) /
15 Amper

FİYAT: 1,19 \$

ÜRÜN KODU	XV-154-1C25
KONTAK TİPİ	1NO+1NC
AÇIKLAMA	Çengel Palet
KUTU ADEDİ	100 Adet

XV-155-1C25

 Mikro Switch
(Silver Contact) /
15 Amper

FİYAT: 1,19 \$

ÜRÜN KODU	XV-155-1C25
KONTAK TİPİ	1NO+1NC
AÇIKLAMA	Kısa Palet Pls. Makaralı
KUTU ADEDİ	100 Adet

XV-156-1C25

 Mikro Switch
(Silver Contact) /
15 Amper

FİYAT: 1,19 \$

ÜRÜN KODU	XV-156-1C25
KONTAK TİPİ	1NO+1NC
AÇIKLAMA	Uzun Palet Makaralı
KUTU ADEDİ	100 Adet

Boş Kumanda Kutuları

ELX-BOX-1

1'li Boş Buton Kutusu

FİYAT: 1,12 \$

ÖLÇÜLER		
U	GD	D
70	70	60



ELX-BOX-1K

1'li Boş Buton Kutusu Korumalı

FİYAT: 1,85 \$

ÖLÇÜLER		
U	GD	D
70	70	60



Boş Buton Kutuları
(IP44)



Teknik Özellikler

ÜRÜN KODU	AÇIKLAMA	K. ADEDİ	FİYAT
LAY5 (DB2) Box1	1'li Boş Kumanda Kutusu	100	1,12 \$
LAY5 (DB2) Box2	2'li Boş Kumanda Kutusu	100	2,25 \$
LAY5 (DB2) Box3	3'lü Boş Kumanda Kutusu	75	2,75 \$
LAY5 (DB2) Box4	4'lü Boş Kumanda Kutusu	50	3,30 \$
LAY5 (DB2) Box5	5'li Boş Kumanda Kutusu	50	4,18 \$
LAY5 (DB2) Box6	6'li Boş Kumanda Kutusu	25	4,50 \$
LAY5 (DB2) Box7	7'li Boş Kumanda Kutusu	25	4,83 \$

Kutulu Montajlı Ürünler

ELX-BX1-AS

Acil Stop
40 mm 1NC Kalıcı Kutu

FİYAT: 3,37 \$

ÖLÇÜLER		
U	G	D
70	70	60



ELX-BX1-ASK

Acil Stop 40 mm 1NC
Kalıcı Korumalı Kutu

FİYAT: 3,60 \$

ÖLÇÜLER		
U	G	D
70	70	60



ELX-ALM-1

Kutulu Tekli Alarm Butonu

FİYAT: 3,2 \$

ÖLÇÜLER		
U	G	D
70	70	60



ELX-K

Buton Koruma Kapađı

FİYAT: 0,525 \$

ÖLÇÜLER		
U	G	D
54	47	35



Kutulu Montajlı Ürünler

ELX-PAS-1

1'li Alarm Seti

FİYAT :7,30 \$

ÖLÇÜLER		
U	G	D
120	70	60

- * 9 V Pili 120db
- * 6 Ton Siren



ELX-BYP-B-24 VDC

Bypass Flaşör Sesli İkaz
Bypass Buzzer

FİYAT: 4,05 \$

ÖLÇÜLER		
U	G	D
70	70	60



ELX-KDRR-EG61

Kuyu Dışından
Revizyon Reset Anahtar

FİYAT: 4,50 \$

ÖLÇÜLER		
U	G	D
70	70	60



ELX-KAB-EA21

Kuyu Aydınlatma Butonu

FİYAT :3,60 \$

ÖLÇÜLER		
U	G	D
70	70	60



Kumanda Kutuları

ELX-BX5-4

4'lü Revizyon Kutusu

FİYAT: 10,30 \$

ÖLÇÜLER		
U	G	D
190	65	70

ELX-BX5-5

 5'li Revizyon Kutusu
Ortası Mavi

FİYAT: 11,30 \$

ÖLÇÜLER		
U	G	D
190	65	70

ELX-BX6-5P

 6'lı Revizyon Kutusu Ortası Boş,
Alarm, Buzzer ve Prizli

FİYAT: 14,50 \$

ÖLÇÜLER		
U	G	D
300	80	70

ELX-BX6-6N

 6'lı Revizyon Kutusu
Yeni Tip

FİYAT: 15,90 \$

ÖLÇÜLER		
U	G	D
200	70	70



* ÜRÜNLERİMİZ MIKNATIS TABANLIDIR.

Kumanda Kutuları

ELX-ELP-RK

Prizli Revizyon Kutusu

FİYAT: 10 \$

ÖLÇÜLER		
U	G	D
170	80	70



* ÜRÜNLERİMİZ MIKNATIS TABANLIDIR.

ELX-EL3BYLS-RK

3 Kademe By Pass'lı
Ledli Sinyalli Revizyon Kutusu

FİYAT: 15,00 \$

ÖLÇÜLER		
U	G	D
170	80	70



ELX-EL3B-PLS-RK

3 Kademe By Pass'lı Prizli,
Ledli Sinyalli Revizyon Kutusu

FİYAT: 17,47 \$

ÖLÇÜLER		
U	G	D
170	80	70



ELX-ELK5

5'li Revizyon Kutusu
İki Korumalı

FİYAT: 13,00 \$

ÖLÇÜLER		
U	G	D
170	80	70



* ÜRÜNLERİMİZ MIKNATIS TABANLIDIR.

ELX-EL3BY-RK

3 Kademe By Paslı
Kuyu Aydınlatma Kutusu

FİYAT SORUNUZ

ÖLÇÜLER		
U	G	D
130	95	75



Kumanda Kutuları

ELX-ELK4

4'lü Revizyon Kutusu
İki Korumalı

FİYAT: 11,25 \$

ÖLÇÜLER		
U	G	D
170	80	70

* ÜRÜNÜMÜZ
MIKNATIS
TABANLIDIR.



ELX-BX-7K

7'li El Kumanda Kuyu Dibi

FİYAT: 17,90 \$

ÖLÇÜLER		
U	G	D
300	70	70



* ÜRÜNÜMÜZ MIKNATIS TABANLIDIR.

ELX-BX-7P

7'li El Kumanda
Prizli, Buzzerli Revizyon

FİYAT: 19,50 \$

ÖLÇÜLER		
U	G	D
300	70	70



* ÜRÜNÜMÜZ MIKNATIS TABANLIDIR.

ELX-BX6-6

6'li Revizyon Kutusu

FİYAT: 15,00 \$

ÖLÇÜLER		
U	G	D
300	80	70



Kumanda Kutuları

ELX-KY-10

10'lu Kuyu Dibi Kutusu

FİYAT: 22,54 \$

ÖLÇÜLER		
U	G	D
235	130	110



ELX-AKDMİ-7

Asansör Kuyu Dibi Kutusu

FİYAT: 20,00 \$

ÖLÇÜLER		
U	G	D
200	130	100



ELX-2MSK-K5

5'li Revizyon Kutusu

2M Silikon Kılıflı Buton,2 Korumalı

FİYAT: Sorunuz

ÖLÇÜLER		
U	G	D
170	80	70



Kumanda Kutuları

ELX-ELK6 BYPASLI

5 Butonlu Sinyalli Revizyon



ELX-BX6-6M

6lı Revizyon Kutusu Metal



FİYAT SORUNUZ



Asansör Kumanda Sistemi ve Kuyu Bileşenleri

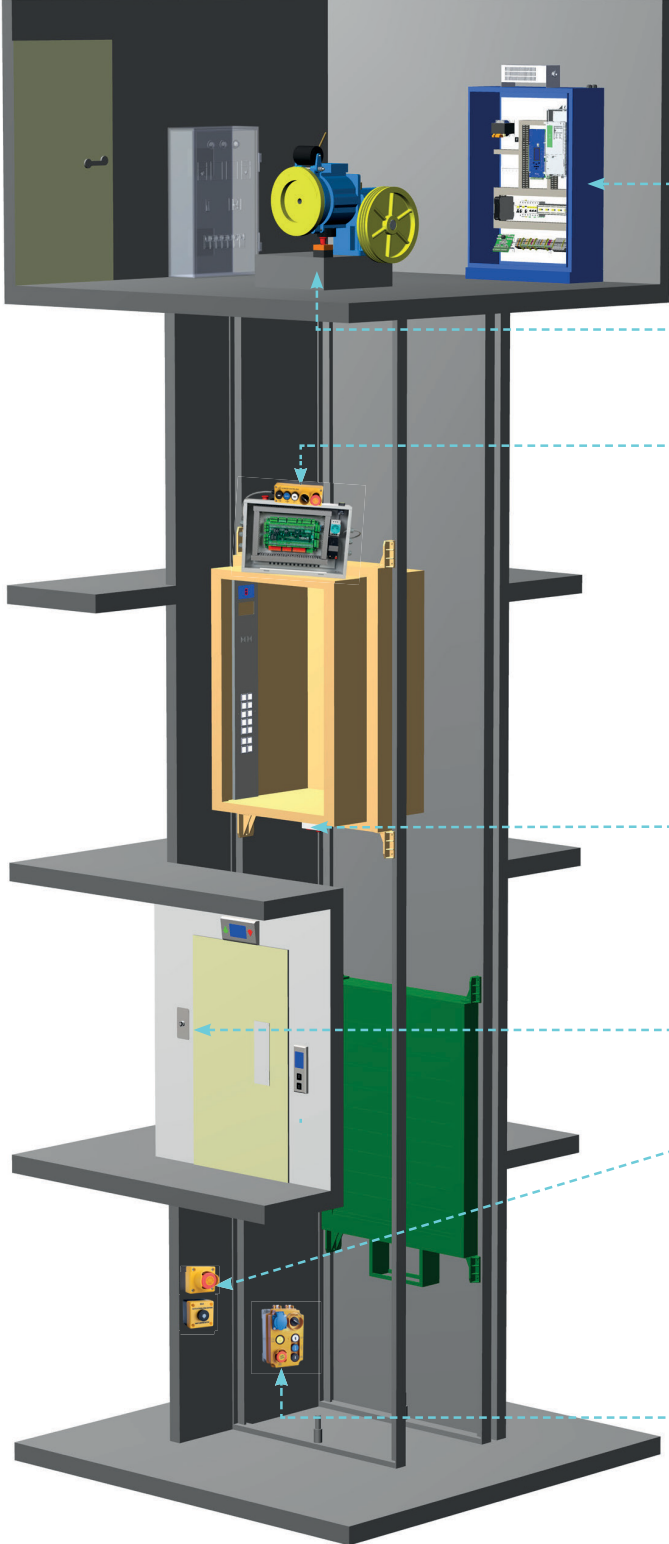

4'lü EI Terminali
ELX-BX5-4

Kumanda Panosu
Control Panel



Durdurma Anahtarı
Emergency Stop



Kabin Üzeri Revizyon Seti
Car-Roof Inspection Box

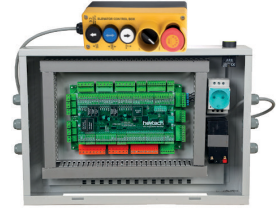

5'li EI Terminali
ELX-BX5-5

Bypass Tertibat Sireni
Bypass Siren



ELX-BYP-B-24 VDC

Reset Anahtarı
Electrical Reset Switch



ELX-KDRR-EG61

Durdurma ve Kuyu Ayd. Butonu
Emergency Stop and Shaft Lighting Button Box



ELX-BX1-ASK

Muayene Kumanda İstasyonu
Inspection Control Station (Pit)



ELX-KAB-EA21



ELX-AKDMİ-7

LAY 5 Plastik Buton Serisi

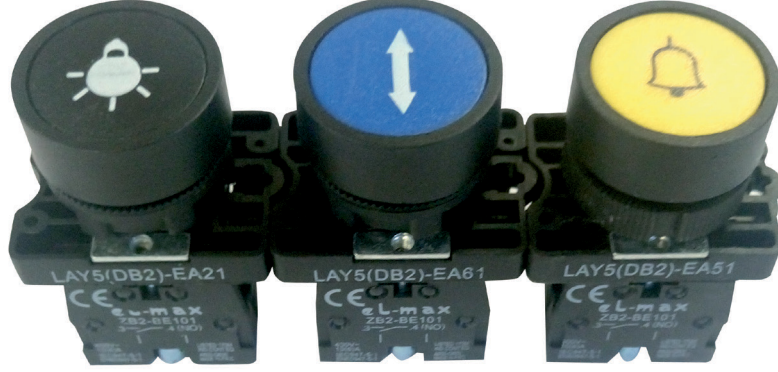

Yaylı Butonlar 250 VAC/3A (IP44)



Teknik Özellikler

ÜRÜN KODU	RENK	KONTAK	K. ADEDİ	AÇIKLAMA	FİYAT
LAY5 (DB2) EA31	Yeşil	1 NO	20	Q22mm Start Buton	1,10 \$
LAY5 (DB2) EA42	Kırmızı	1 NC	20	Q22mm Stop Buton	1,10 \$
LAY5 (DB2) EA51	Sarı	1 NO	20	Q22mm Start Buton	1,10 \$
LAY5 (DB2) EA21	Siyah	1 NO	20	Q22mm Start Buton	1,10 \$

İşaretli Yaylı Butonlar 250 VAC/3A (IP44)



Teknik Özellikler

ÜRÜN KODU	KONTAK	K. ADEDİ	AÇIKLAMA	FİYAT
LAY5 (DB2) EA21	1 NO	20	Q22mm Siyah Tabanlı, Beyaz Lamba	1,20 \$
LAY5 (DB2) EA51	1 NO	20	Q22mm Sarı Tabanlı, Siyah Zilli	1,20 \$
LAY5 (DB2) EA61	1 NO	20	Q22mm Mavi Tabanlı, Çift Yönlü Ok	1,20 \$
LAY5 (DB2) EA3341	1 NO	20	Q22mm Beyaz Tabanlı, Siyah Ok	1,20 \$
LAY5 (DB2) EA3351	1 NO	20	Q22mm Siyah Tabanlı, Beyaz Ok	1,20 \$

Mandal Butonlar 250 VAC/3A (IP44)



Teknik Özellikler

ÜRÜN KODU	KONUM	KONTAK	K. ADEDİ	AÇIKLAMA	FİYAT
LAY5 (DB2) ED21	0-1 Kalıcı	1 NO	20	Q22mm Kalıcı Mandal Buton	1,25 \$
LAY5 (DB2) ED41	0-(1)Kayıcı	1 NO	20	Q22mm Kayıcı Mandal Buton	1,45 \$
LAY5 (DB2) ED33	1-0-2 Kalıcı	1 NO+1NO	20	Q22mm Kalıcı Mandal Buton	2,60 \$
LAY5 (DB2) ED53	1-0-2 Kayıcı	1 NO+1NO	20	Q22mm Kayıcı Mandal Buton	2,70 \$

LAY 5 Plastik Buton Serisi



40mm İkiz Butonlar 250 VAC/3A (IP44)

Teknik Özellikler

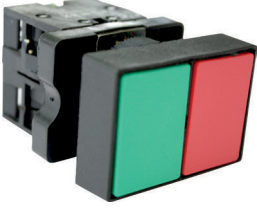

ÜRÜN KODU	RENK	KONTAK	K. ADEDİ	AÇIKLAMA	FİYAT
LAY5 (DB2) EL8325	Yeşil - Kırmızı	1 NO+1 NC	20	Q22mm İkiz Buton	3,70 \$

40mm Mantar Butonlar 250 VAC/3A (IP44)

Teknik Özellikler



ÜRÜN KODU	RENK	KONTAK	K. ADEDİ	AÇIKLAMA	FİYAT
LAY5 (DB2) ES542	Kırmızı	1 NC	20	Q40mm Acil Stop Mantar	1,68 \$
LAY5 (DB2) ES442	Kırmızı	1 NC	20	Q30mm Acil Stop Mantar	1,68 \$
LAY5 (DB2) ES142	Kırmızı	1 NC	20	Q40mm Anahtarlı Buton	3,94 \$
LAY5 (DB2) EC42	Kırmızı	1 NC	20	Q40mm Acil Stop Mantar	1,80 \$
LAY5 (DB2) EC31	Yeşil	1 NO	20	Q40mm Acil Stop Mantar	1,80 \$

Anahtarlı Buton

Teknik Özellikler



ÜRÜN KODU	KONUM	KONTAK	K. ADEDİ	AÇIKLAMA	FİYAT
LAY5 (DB2) EG41	Kalıcı	1 NO	20	Q22mm 0-1 Kalıcı	3,38 \$
LAY5 (DB2) EG61	Kayıcı	1 NO	20	Q22mm 0-1 Kayıcı	3,38 \$
LAY5 (DB2) EG73	1-0-2 Kayıcı	2 NO	20	Q22mm 1-0-2 Kayıcı	3,69 \$

LAY 5 Metal Buton Serisi



Yaylı Butonlar 250 VAC/3A (IP44)

Teknik Özellikler



ÜRÜN KODU	RENK	KONTAK	K. ADEDİ	AÇIKLAMA	FİYAT
LAY5 (DB2) BA31	Yeşil	1 NO	20	Q22mm Start Buton	2,11 \$
LAY5 (DB2) BA42	Kırmızı	1 NC	20	Q22mm Stop Buton	2,11 \$
LAY5 (DB2) BA51	Sarı	1 NO	20	Q22mm Start Buton	2,11 \$
LAY5 (DB2) BA21	Siyah	1 NO	20	Q22mm Start Buton	2,11 \$

İşaretili Yaylı Butonlar 250 VAC/3A (IP44)

Teknik Özellikler



ÜRÜN KODU	RENK	KONTAK	K. ADEDİ	AÇIKLAMA	FİYAT
LAY5 (DB2) BA3341	Beyaz	1 NO	20	Q22mm Start Buton	2,27 \$
LAY5 (DB2) BA3351	Siyah	1 NO	20	Q22mm Start Buton	2,27 \$

40mm Mantar Butonlar 250 VAC/3A (IP44)

Teknik Özellikler



ÜRÜN KODU	RENK	KONTAK	K. ADEDİ	AÇIKLAMA	FİYAT
LAY5 (DB2) BS542	Kırmızı	1 NC	20	Q40mm Acil Stop Mantar Kalıcı	2,82 \$
LAY5 (DB2) BC21	Siyah	1 NO	20	Q40mm Yaylı Mantar Buton Kayıcı	2,82 \$

40mm İkiz Butonlar 250 VAC/3A (IP44)

Teknik Özellikler



ÜRÜN KODU	RENK	KONTAK	K. ADEDİ	AÇIKLAMA	FİYAT
LAY5 (DB2) BL8325	Kır-Yeşil	1 NO+1NC	20	Q22mm İkiz Buton	4,45 \$

LAY 5 Metal Buton Serisi / Joystick Kontrol Yedek Kontak / Potansiyometre

Kalıcı Mandal Butonlar 250 VAC/3A (IP44)

Teknik Özellikler



ÜRÜN KODU	KONUM	KONTAK	K. ADEDİ	AÇIKLAMA	FİYAT
LAY5 (DB2) BD21	0-1 Kalıcı	1 NO	20	Q22mm Kalıcı Mandal Buton	2,43 \$
LAY5 (DB2) BD33	1-0-2 Kalıcı	1NO + 1NO	20	Q22mm Kalıcı Mandal Buton	3,10 \$

Anahtarlı Buton

Teknik Özellikler



ÜRÜN KODU	KONUM	KONTAK	K. ADEDİ	AÇIKLAMA	FİYAT
LAY5 (DB2) BG41	0-1 Kalıcı	1 NO	20	Q22mm Anahtarlı Buton	4,63 \$

Joystick Kontrol

Teknik Özellikler



ÜRÜN KODU	RENK	KONTAK	K. ADEDİ	AÇIKLAMA	FİYAT
LAY5 (DB2) PA22	Gri-Siyah	2 N/O	10	Metal 2 Yönlü Yaylı	18,60 \$

Yedek Kontak Blok 250 VAC/3A (IP44)

Teknik Özellikler



ÜRÜN KODU	RENK	KONTAK	K. ADEDİ	AÇIKLAMA	FİYAT
LAY5 (DB2) BE101	Yeşil	1 NO	100	Yedek Kontak Blok	0,55 \$
LAY5 (DB2) BE102	Kırmızı	1 NC	100	Yedek Kontak Blok	0,55 \$

Ø 22mm Potansiyometre Tek Tur

Teknik Özellikler



ÜRÜN KODU	KONTAK	K. ADEDİ	AÇIKLAMA	FİYAT
ELX PT 5K	5K (Tek Tur)	10	Ø22mm Potansiyometre	6,30 \$
ELX PT 10K	10K (Tek Tur)	10	Ø22mm Potansiyometre	6,30 \$

ELX2M Plastik Buton Serisi

Yaylı Butonlar Q22mm







Teknik Özellikler

ÜRÜN KODU	RENK	KONTAK	K. ADEDİ	AÇIKLAMA	FİYAT
ELX2M-10	Yeşil	1 NO	10	Yaylı Buton	2,30 \$
ELX2M-01	Kırmızı	1 NC	10	Yaylı Buton	2,30 \$
ELX2M-11	Sarı	1 NO	10	Yaylı Buton	2,30 \$
ELX2M-21	Mavi	1 NO	10	Yaylı Buton	2,30 \$
ELX2M-31	Beyaz	1 NO	10	Yaylı Buton	2,30 \$
ELX2M-41	Siyah	1 NO	10	Yaylı Buton	2,30 \$

İşaretli Yaylı Butonlar Q22mm



Teknik Özellikler

ÜRÜN KODU	KONTAK	K. ADEDİ	AÇIKLAMA	FİYAT
ELX2M-1011	1 NO	10	İşaretli Yaylı Buton 	2,60 \$
ELX2M-1012	1 NC	10	İşaretli Yaylı Buton 	2,60 \$
ELX2M-1013	1 NO	10	İşaretli Yaylı Buton 	2,60 \$
ELX2M-1014	1 NO	10	İşaretli Yaylı Buton 	2,60 \$

İşikly Yaylı Butonlar Q22mm



Teknik Özellikler

ÜRÜN KODU	RENK	KONTAK	K. ADEDİ	AÇIKLAMA	FİYAT
ELX2M-10L	Yeşil	1 NO	10	İşikly Yaylı Buton 220V AC/DC	4,18 \$
ELX2M-01L	Kırmızı	1 NC	10	İşikly Yaylı Buton 220V AC/DC	4,18 \$
ELX2M-11L	Sarı	1 NO	10	İşikly Yaylı Buton 220V AC/DC	4,18 \$
ELX2M-21L	Mavi	1 NO	10	İşikly Yaylı Buton 220V AC/DC	4,18 \$
ELX2M-31L	Beyaz	1 NO	10	İşikly Yaylı Buton 220V AC/DC	4,18 \$
ELX2M-10L-24	Yeşil	1 NO	10	İşikly Yaylı Buton 24V AC/DC	4,18 \$
ELX2M-01L-24	Kırmızı	1NC	10	İşikly Yaylı Buton 24V AC/DC	4,18 \$
ELX2M-11L-24	Sarı	1 NO	10	İşikly Yaylı Buton 24V AC/DC	4,18 \$
ELX2M-21L-24	Mavi	1 NO	10	İşikly Yaylı Buton 24V AC/DC	4,18 \$
ELX2M-31L-24	Beyaz	1 NO	10	İşikly Yaylı Buton 24V AC/DC	4,18 \$

ELX2M Plastik Buton Serisi

Kalıcı Mandal Butonlar Q22mm

Teknik Özellikler



ÜRÜN KODU	KONTAK	K. ADEDİ	AÇIKLAMA	FİYAT
ELX2M-10KL	1 NO	10	0 - 1 Mandal Buton	2,60 \$
ELX2M-20KL	2 NO	10	1 - 0 - 2 Mandal Buton	3,45 \$

Kayıcı Mandal Butonlar Q22mm

Teknik Özellikler



ÜRÜN KODU	KONTAK	K. ADEDİ	AÇIKLAMA	FİYAT
ELX2M-10KY	1 NO	10	0 - 1 Mandal Buton	3,00 \$
ELX2M-20KY	2 NO	10	1 - 0 - 2 Mandal Buton	3,85 \$

Anahtarlı Kalıcı Butonlar Q22mm

Teknik Özellikler



ÜRÜN KODU	KONTAK	K. ADEDİ	AÇIKLAMA	FİYAT
ELX2M-10AN	1 NO	10	0 - 1 Anahtarlı Buton	3,85 \$
ELX2M-20AN	2 NO	10	1 - 0 - 2 Anahtarlı Buton	4,78 \$

**ELX2M Plastik Buton Serisi
Buton Serisi Aksesuarları**
Işıklı Kalıcı Mandal Butonlar Q22mm

Teknik Özellikler

ÜRÜN KODU	RENK	KONTAK	K. ADEDİ	AÇIKLAMA	FİYAT
ELX2M-10LK	Yeşil	1 NO	10	0-1 Işıklı MANDAL Buton 220V AC/DC	4,20 \$
ELX2M-01LK	Kırmızı	1 NC	10	0-1 Işıklı MANDAL Buton 220V AC/DC	4,20 \$
ELX2M-11LK	Sarı	1 NO	10	0-1 Işıklı MANDAL Buton 220V AC/DC	4,20 \$
ELX2M-10LK-24	Yeşil	1 NO	10	0-1 Işıklı MANDAL Buton 24V AC/DC	4,20 \$
ELX2M-01LK-24	Kırmızı	1 NC	10	0-1 Işıklı MANDAL Buton 24V AC/DC	4,20 \$
ELX2M-11LK-24	Sarı	1 NO	10	0-1 Işıklı MANDAL Buton 24V AC/DC	4,20 \$
ELX2M-20LK-24	Yeşil	2 NO	10	1-0-2 Işıklı MANDAL Buton 24V AC/DC	5,28 \$
ELX2M-02LK-24	Kırmızı	2 NC	10	1-0-2 Işıklı MANDAL Buton 24V AC/DC	5,28 \$
ELX2M-21LK-24	Sarı	2 NO	10	1-0-2 Işıklı MANDAL Buton 24V AC/DC	5,28 \$
ELX2M-20LK	Yeşil	2 NO	10	1-0-2 Işıklı MANDAL Buton 220V AC/DC	5,28 \$

Kalıcı Mantar Butonlar Q22mm



Teknik Özellikler

ÜRÜN KODU	KONTAK	K. ADEDİ	AÇIKLAMA	FİYAT
ELX2M-01AS	1 NC	10	Stop Mantar Buton	2,97 \$

İkiz Butonlar Q22mm

Teknik Özellikler

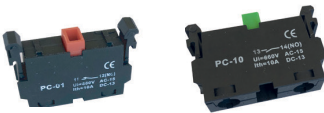
ÜRÜN KODU	KONTAK	K. ADEDİ	AÇIKLAMA	FİYAT
ELX2M-11TBR	1 NO + 1 NC	10	Start	4,30 \$
ELX2M-11TBL	1 NO + 1 NC	10	Işıklı İkiz Buton 220V AC/DC	5,70 \$

Buton Aksesuarları Q22mm

Teknik Özellikler

ÜRÜN KODU	KONTAK	K. ADEDİ	AÇIKLAMA	FİYAT
ELX2M-11A	1 NO	250	Start Kontak	1,04 \$
ELX2M-01A	1 NC	250	Stop Kontak	1,04 \$

İzoleli Kablo Yüksükleri (Bakır Copper)

Standart : DIN 46228
Malzeme : Bakır Kalay Kaplı
İzolasyon : Naylon
Çalışma Sıcaklığı : Max 105°
600 Volt Arası



Standart : DIN 46228
Malzeme : Bakır Kalay Kaplı
İzolasyon : Naylon



İzoleli Kablo Yüksükleri Wire End Sleeves Insul / KUTULU

ÜRÜN KODU	KESİT (mm)	FRANCE NORM	BOYUTLAR		PLS KUTU / ADET	FİYAT
			F mm	L mm		
ELX İY 3005	0,50	Beyaz	8	12	1,000	0,218 ₺
ELX İY 3007	0,75	Mavi	8	14	1,000	0,218 ₺
ELX İY 3010	1	Kırmızı	8	14	1,000	0,218 ₺
ELX İY 3015	1,5	Siyah	8	14	1,000	0,237 ₺
ELX İY 3025	2,5	Gri	8	14	500	0,303 ₺
ELX İY 3040	4	Turuncu	10	17	500	0,500 ₺
ELX İY 3060	6	Yeşil	12	20	250	0,678 ₺
ELX İY 3100	10	Kahverengi	12	22	100	0,858 ₺
ELX İY 3160	16	Bej	12	24	100	1,22 ₺
ELX İY 3250	25	Siyah	16	28	50	2,10 ₺
ELX İY 3350	35	Kırmızı	16	30	50	2,52 ₺
ELX İY 3500	50	Mavi	20	36	25	4,80 ₺

İzoleli Kablo Yüksükleri Wire End Sleeves Insul / KUTULU

ÜRÜN KODU	KESİT (mm)	GERMANY NORM	BOYUTLAR		PLS KUTU / ADET	FİYAT
			F mm	L mm		
ELX İY 2005	0,50	Turuncu	8	12	1,000	0,218 ₺
ELX İY 2007	0,75	Beyaz	8	14	1,000	0,218 ₺
ELX İY 2010	1	Sarı	8	14	1,000	0,218 ₺
ELX İY 2015	1,5	Kırmızı	8	14	1,000	0,237 ₺
ELX İY 2025	2,5	Mavi	8	14	500	0,303 ₺
ELX İY 2040	4	Gri	10	17	500	0,500 ₺
ELX İY 2060	6	Siyah	12	20	250	0,678 ₺
ELX İY 2100	10	Bej	12	22	100	0,858 ₺
ELX İY 2160	16	Yeşil	12	24	100	1,22 ₺
ELX İY 2250	25	Kahverengi	16	28	50	2,10 ₺
ELX İY 2350	35	Bej	16	30	50	2,52 ₺
ELX İY 2500	50	Siyah	20	36	25	4,80 ₺

İzoleli Çift Girişli Kablo Yüksükleri Twin Wire End Sleeves Insul / KUTULU

ÜRÜN KODU	KESİT mm	FRANCE NORM Fransız	GERMANY NORM Alman	BOYUTLAR		PLS KUTU Adet	FİYAT
				F mm	L mm		
ELX CY 23005	0,50	Beyaz	Kahverengi	8	14	500	0,384 ₺
ELX CY 23007	0,75	Mavi	Beyaz	8	14	500	0,404 ₺
ELX CY 23010	1	Kırmızı	Sarı	8	14	500	0,429 ₺
ELX CY 23015	1,5	Siyah	Kırmızı	8	14	500	0,519 ₺
ELX CY 23025	2,5	Gri	Mavi	10	14	250	0,848 ₺
ELX CY 23040	4	Turuncu	Gri	12	17	200	0,975 ₺
ELX CY 23060	6	Yeşil	Siyah	14	20	100	1,208 ₺
ELX CY 23100	10	Kahverengi	Beyaz	14	27	100	1,926 ₺
ELX CY 23160	16	Bej	Yeşil	14	31	50	2,325 ₺

İzoleli Pabuçlar

İzoleli 0,50-1,50 Kablo Girişli Yuvarlak Pabuçlar

Standart : DIN 46237
Malzeme : Bakır Kalay Kaplı
İzolasyon : PVC
Çalışma Sıcaklığı : Max 105°
600 Volt Arası



Teknik Özellikler

ÜRÜN KODU	RENK	KESİT	K. ADEDİ	AÇIKLAMA	FİYAT
ELX YU 301	■ Kırmızı	0,50 - 1,5	200	M 3 İzoleli Pabuçlar	0,989 ₺
ELX YU 401	■ Kırmızı	0,50 - 1,5	200	M 4 İzoleli Pabuçlar	1,028 ₺
ELX YU 501	■ Kırmızı	0,50 - 1,5	200	M 5 İzoleli Pabuçlar	1,038 ₺
ELX YU 601	■ Kırmızı	0,50 - 1,5	200	M 6 İzoleli Pabuçlar	1,631 ₺
ELX YU 801	■ Kırmızı	0,50 - 1,5	200	M 8 İzoleli Pabuçlar	1,680 ₺

İzoleli 0,50-250 Kablo Girişli Yuvarlak Pabuçlar



Teknik Özellikler

ÜRÜN KODU	RENK	KESİT	K. ADEDİ	AÇIKLAMA	FİYAT
ELX YU 302	■ Mavi	1,50 - 2,5	200	M 3 İzoleli Pabuçlar	1,260 ₺
ELX YU 402	■ Mavi	1,50 - 2,5	200	M 4 İzoleli Pabuçlar	1,260 ₺
ELX YU 502	■ Mavi	1,50 - 2,5	200	M 5 İzoleli Pabuçlar	1,283 ₺
ELX YU 602	■ Mavi	1,50 - 2,5	200	M 6 İzoleli Pabuçlar	1,824 ₺
ELX YU 802	■ Mavi	1,50 - 2,5	200	M 8 İzoleli Pabuçlar	1,827 ₺
ELX YU 1002	■ Mavi	1,50 - 2,5	200	M 10 İzoleli Pabuçlar	1,830 ₺
ELX YU 1202	■ Mavi	1,50 - 2,5	200	M 12 İzoleli Pabuçlar	2,250 ₺

İzoleli 4,0 - 6,0 Kablo Girişli Yuvarlak Pabuçlar

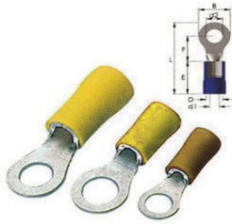

Teknik Özellikler

ÜRÜN KODU	RENK	KESİT	K. ADEDİ	AÇIKLAMA	FİYAT
ELX YU 406	■ Sarı	4,0 - 6,0	100	M 4 İzoleli Pabuçlar	2,655 ₺
ELX YU 506	■ Sarı	4,0 - 6,0	100	M 5 İzoleli Pabuçlar	2,655 ₺
ELX YU 606	■ Sarı	4,0 - 6,0	100	M 6 İzoleli Pabuçlar	2,985 ₺
ELX YU 806	■ Sarı	4,0 - 6,0	100	M 8 İzoleli Pabuçlar	3,795 ₺
ELX YU 1006	■ Sarı	4,0 - 6,0	100	M 10 İzoleli Pabuçlar	3,840 ₺
ELX YU 1206	■ Sarı	4,0 - 6,0	100	M 12 İzoleli Pabuçlar	3,915 ₺

İzoleli 0,50 - 1,5 Kablo Girişli Çatal Pabuçlar

Standart : DIN 46237
Malzeme : Bakır Kalay Kaplı
İzolasyon : PVC
Çalışma Sıcaklığı : Max 105°
600 Volt Arası

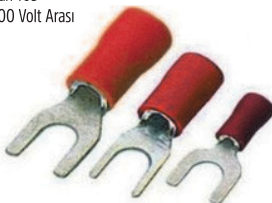

Teknik Özellikler

ÜRÜN KODU	RENK	KESİT	K. ADEDİ	AÇIKLAMA	FİYAT
ELX ÇU 3001	■ Kırmızı	0,50 - 1,5	200	M 3 İzoleli Pabuçlar	0,900 ₺
ELX ÇU 4001	■ Kırmızı	0,50 - 1,5	200	M 4 İzoleli Pabuçlar	0,917 ₺
ELX ÇU 5001	■ Kırmızı	0,50 - 1,5	200	M 5 İzoleli Pabuçlar	0,975 ₺
ELX ÇU 6001	■ Kırmızı	0,50 - 1,5	200	M 6 İzoleli Pabuçlar	1,104 ₺

İzoleli Pabuçlar

İzoleli 1,50 - 2,5 Kablo Girişli Çatal Pabuçlar



Teknik Özellikler

ÜRÜN KODU	RENK	KESİT	K. ADEDİ	AÇIKLAMA	FİYAT
ELX ÇU 3002	Mavi	1,5 - 2,5	200	M 3 İzoleli Pabuçlar	1,013 ₺
ELX ÇU 4002	Mavi	1,5 - 2,5	200	M 4 İzoleli Pabuçlar	1,040 ₺
ELX ÇU 5002	Mavi	1,5 - 2,5	200	M 5 İzoleli Pabuçlar	1,058 ₺
ELX ÇU 6002	Mavi	1,5 - 2,5	200	M 6 İzoleli Pabuçlar	1,422 ₺

İzoleli 4,0 - 6,0 Kablo Girişli Çatal Pabuçlar



Teknik Özellikler

ÜRÜN KODU	RENK	KESİT	K. ADEDİ	AÇIKLAMA	FİYAT
ELX ÇU 4006	Sarı	4,0 - 6,0	100	M 4 İzoleli Pabuçlar	2,340 ₺
ELX ÇU 5006	Sarı	4,0 - 6,0	100	M 5 İzoleli Pabuçlar	2,400 ₺
ELX ÇU 6006	Sarı	4,0 - 6,0	100	M 6 İzoleli Pabuçlar	3,180 ₺
ELX ÇU 8006	Sarı	4,0 - 6,0	100	M 8 İzoleli Pabuçlar	3,645 ₺

İğne Tip İzoleli Kablo Uçları



Teknik Özellikler

Malzeme : Bakır Kalay Kaplı
İzolasyon : PVC
Çalışma Sıcaklığı : Max 75° / 300 Volt Arası

ÜRÜN KODU	RENK	KESİT	K. ADEDİ	AÇIKLAMA	FİYAT
ELX K 101	Kırmızı	0,5 - 1,5	200	1,9 x 10,5 Kablo Uçları	1,067 ₺
ELX K 102	Mavi	1,5 - 2,5	200	1,9 x 20,5 Kablo Uçları	1,256 ₺
ELX K 106	Sarı	4,0 - 6,0	200	2,8 x 26 Kablo Uçları	3,150 ₺

Kurşun Tip Dişi Terminal



Teknik Özellikler

Malzeme : Pirinç, Kalay Kaplı
Bakır Yüksüklü
İzolasyon : PVC
Çalışma Sıcaklığı : Max 75° / 300 Volt Arası

ÜRÜN KODU	RENK	KESİT	K. ADEDİ	AÇIKLAMA	FİYAT
ELX BD 1040	Kırmızı	0,5 - 1,5	200	Q4 L9 Dişi Terminal	2,85 ₺
ELX BD 2050	Mavi	1,5 - 2,5	200	Q5 L9 Dişi Terminal	3,18 ₺

Terminal



Kurşun Tip Erkek Terminal



Teknik Özellikler

Malzeme : Pirinç, Kalay Kaplı
Bakır Yüksüklü
İzolasyon : PVC
Çalışma Sıcaklığı : Max 75° / 300 Volt Arası

ÜRÜN KODU	RENK	KESİT	K. ADEDİ	AÇIKLAMA	FİYAT
ELX BE 2050	Mavi	1,5 - 2,5	200	Q5 L8,5 Erkek Terminal	2,715₺

Tam İzole PVC Dişi Terminal



Teknik Özellikler

Malzeme : Pirinç, Kalay Kaplı
İzolasyon : PVC
Çalışma Sıcaklığı : Max 75° / 300 Volt Arası

ÜRÜN KODU	RENK	KESİT	K. ADEDİ	AÇIKLAMA	FİYAT
ELX FFD 1488	Kırmızı	0,5 - 1,5	200	4,8 mm	1,533 ₺
ELX FFD 1638	Kırmızı	0,5 - 1,5	100	6,3 mm	1,77 ₺
ELX FFD 2488	Mavi	1,5 - 2,5	200	4,8 mm	1,695 ₺
ELX FFD 2638	Mavi	1,5 - 2,5	100	6,3 mm	1,770 ₺
ELX FFD 5638	Sarı	4,0 - 6,0	200	6,3 mm	2,22 ₺

Terminal

İzoleli Diři Terminal

Malzeme : Piriç, Kalay Kaplı
İzolasyon : PVC
Çalışma Sıcaklığı : Max 75° / 300 Volt Arası



ÜRÜN KODU	RENK	KESİT	K. ADEDİ	AÇIKLAMA	FİYAT
ELX FD 1288	■ Kırmızı	0,5-1,5	200	2,8 mm Diři Terminal	0,89 ₺
ELX FD 1488	■ Kırmızı	0,5-1,5	200	4,8 mm Diři Terminal	1,14 ₺
ELX FD 1638	■ Kırmızı	0,5-1,5	200	6,3 mm Diři Terminal	1,32 ₺
ELX FD 2638	■ Mavi	1,5-2,5	200	6,3 mm Diři Terminal	1,65 ₺
ELX FD 5638	■ Sarı	4,0-6,0	150	6,3 mm Diři Terminal	1,80 ₺

Malzeme : Piriç, Kalay Kaplı
İzolasyon : PVC
Çalışma Sıcaklığı : Max 75° / 300 Volt Arası

İzoleli Erkek Terminal



ÜRÜN KODU	RENK	KESİT	K. ADEDİ	AÇIKLAMA	FİYAT
ELX FE 1288	■ Kırmızı	0,5 - 1,5	200	2,8 mm Terminal	0,909 ₺
ELX FE 1488	■ Kırmızı	0,5 - 1,5	200	4,8 mm Terminal	0,909 ₺
ELX FE 1638	■ Kırmızı	0,5 - 1,5	200	6,3 mm Terminal	1,085 ₺
ELX FE 2488	■ Mavi	1,5 - 2,5	200	4,8 mm Terminal	0,909 ₺
ELX FE 2638	■ Mavi	1,5 - 2,5	200	6,3 mm Terminal	1,185 ₺
ELX FE 5638	■ Sarı	4,0 - 6,0	150	6,3 mm Terminal	1,418 ₺

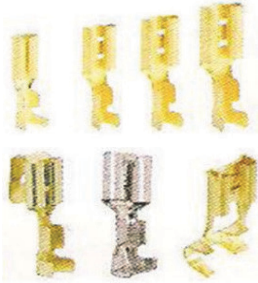

SF1D Kılıf

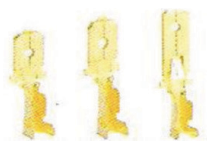

İzolesiz Diři Terminal

ÜRÜN KODU	K. ADEDİ	AÇIKLAMA	FİYAT
ELX SF 1D	300	6,3 Diři Terminal	1,189 ₺
ELX SF 2D	300	6,3 Diři Tırnaklı Terminal	1,189 ₺
ELX SF 1/2D	1000	2,8 Diři Terminal	0,764 ₺
ELX SF 1D Mini	500	4,8 Diři Terminal	0,932 ₺
ELX SF 1D Kılıf	300	6,3 Terminal Kılıfı	0,504 ₺

İzolesiz Erkek Terminal

ÜRÜN KODU	K. ADEDİ	AÇIKLAMA	FİYAT
ELX SF 1EÇK	300	6,3 Kısa Erkek Terminal	1,158 ₺
ELX SF 1EU1	400	6,3 Uzun Erkek Terminal	1,557 ₺

İzolesiz Erkek Terminal

ÜRÜN KODU	K. ADEDİ	AÇIKLAMA	FİYAT
ELX SKN 2,5	500	M4 M5 M6 Topraklama Terminal	1,189 ₺
ELX SKN 4	250	M4 M5 M6 Topraklama Terminal	2,248 ₺
ELX SKN 6	150	M6 Topraklama Terminal	3,427 ₺
ELX SKN 8	150	M8 Topraklama Terminal	3,427 ₺
ELX SKN 10	100	M8 M10 Topraklama Terminal	3,931 ₺

Buzzer ve Ledli Sinyal Lambaları

Led'li Buzzer Q22mm (90dB)

Teknik Özellikler



ÜRÜN KODU	RENK	VOLTAJ	K. ADEDİ	AÇIKLAMA	FİYAT
AD 16 - 22SM/R	Kırmızı	220V AC	10	Q22mm Led'li Buzzer	3,10 \$
AD 16 - 22SM/R	Kırmızı	24V AC/DC	10	Q22mm Led'li Buzzer	3,10 \$

Led'li Sinyal Q22MM 220/240V AC

Teknik Özellikler



ÜRÜN KODU	RENK	VOLTAJ	K. ADEDİ	AÇIKLAMA	FİYAT
AD 22 - 22DS/R	Kırmızı	230V AC	10	Q22mm Led'li Sinyal	0,80 \$
AD 22 - 22DS/G	Yeşil	230V AC	10	Q22mm Led'li Sinyal	0,80 \$
AD 22 - 22DS/Y	Sarı	230V AC	10	Q22mm Led'li Sinyal	0,80 \$
AD 22 - 22DS/B	Mavi	230V AC	10	Q22mm Led'li Sinyal	1,19 \$
AD 22 - 22DS/W	Beyaz	230V AC	10	Q22mm Led'li Sinyal	1,19 \$

Led'li Sinyal Q22MM 24VAC/DC

Teknik Özellikler



ÜRÜN KODU	RENK	VOLTAJ	K. ADEDİ	AÇIKLAMA	FİYAT
AD 22 - 22DS/R	Kırmızı	24V AC-DC	10	Q22mm Led'li Sinyal	0,80 \$
AD 22 - 22DS/G	Yeşil	24V AC-DC	10	Q22mm Led'li Sinyal	0,80 \$
AD 22 - 22DS/Y	Sarı	24V AC-DC	10	Q22mm Led'li Sinyal	0,80 \$
AD 22 - 22DS/B	Mavi	24V AC-DC	10	Q22mm Led'li Sinyal	1,19 \$
AD 22 - 22DS/W	Beyaz	24V AC-DC	10	Q22mm Led'li Sinyal	1,19 \$

Elektronik Sirenler Ø 50mm (120 dB)

Teknik Özellikler



ÜRÜN KODU	RENK	VOLTAJ	K. ADEDİ	AÇIKLAMA	FİYAT
ES -50 -12-24	■ Siyah	12-24V.AC/DC	8	Elektronik Siren Plastik Gövde	5,30 \$

Ledli Voltmetre - Ampermetre Sinyal Lambaları

Q22 mm Ledli Voltmetre Göstergeli Sinyal Lambaları



Teknik Özellikler

ÜRÜN KODU	RENK	VOLTAJ	ÇAP (mm)	K. ADEDİ	FİYAT
AD22-22DS/RV	KIRMIZI	12-500 VAC	22 mm	10	3,50 \$
AD22-22DS/GV	YEŞİL	12-500 VAC	22 mm	10	3,50 \$
AD22-22DS/YV	SARI	12-500 VAC	22 mm	10	3,50 \$

Q22 mm Ledli Voltmetre - Ampermetre Göstergeli Sinyal Lambaları



Teknik Özellikler

ÜRÜN KODU	RENK	VOLTAJ	ÇAP (mm)	K. ADEDİ	FİYAT
AD22-22DS/RAV	KIRMIZI	12-500 VAC 0-100 A	22 mm	5	9,50 \$
AD22-22DS/GAV	YEŞİL	12-500 VAC 0-100 A	22 mm	5	9,50 \$
AD22-22DS/YAV	SARI	12-500 VAC 0-100 A	22 mm	5	9,50 \$

Q22 mm Ledli Ampermetre Göstergeli Sinyal Lambaları



Teknik Özellikler

ÜRÜN KODU	RENK	AMP	ÇAP (mm)	K. ADEDİ	FİYAT
AD22-22DS/RA	KIRMIZI	0-100 A Akım Trafolu	22 mm	5	6,90 \$
AD22-22DS/GA	YEŞİL	0-100 A Akım Trafolu	22 mm	5	6,90 \$
AD22-22DS/YA	SARI	0-100 A Akım Trafolu	22 mm	5	6,90 \$

Ekonomik Kablo Pabuçları

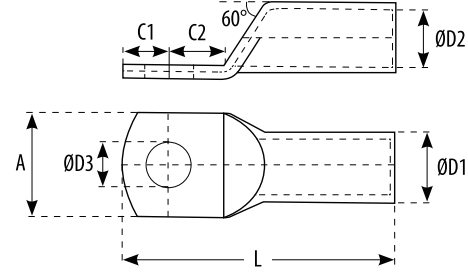

Elektrolit Bakır 99.9
İletkenlik Katsayı min. 56 ms/m

Ürün Kodu	Kablo Kesiti mm ²	Civata	Ölçüler					Kutu Adet	Adet Fiyat (USD)
			D3	D2	D1	L	A		
SKPE-16-06	16	M6	6,5	5,8	7,4	30	12	500	0,282 \$
SKPE-16-08	16	M6	6,5	5,8	7,4	30	12	500	0,326 \$
SKPE-25-08	25	M8	8,5	7,2	9,2	40	14	350	0,445 \$
SKPE-35-08	35	M8	8,5	8,5	11	44	15,3	200	0,626 \$
SKPE-50-10	50	M10	10,5	10	13	52	20	150	0,793 \$
SKPE-70-10	70	M10	10,5	11,5	14,7	55	22	100	1,249 \$
SKPE-95-12	95	M12	13	13,5	16,7	59	26	80	1,475 \$
SKPE-120-12	120	M12	13	15,6	19	70	29	50	2,164 \$
SKPE-150-12	150	M12	13	17	21	77	32	40	3,354 \$
SKPE-185-16	185	M16	17	19	23	85	35	30	3,843 \$
SKPE-240-16	240	M16	17	21	26	90	38,5	25	5,855 \$

Ek Muflar



Ürün Kodu	Uzunluk mm ²	Kutu Adet	Adet Fiyat (USD)
EM-16	32	400	0,348 \$
EM-25	41	250	0,511 \$
EM-35	46	200	0,756 \$
EM-50	54	150	0,838 \$
EM-70	58	100	1,401 \$
EM-95	62	75	1,616 \$
EM-120	74	60	2,316 \$
EM-150	80	40	3,843 \$
EM-185	86	25	4,451 \$
EM-240	95	25	6,341 \$

Standart Kablo Pabuçları

Ürün Kodu	Kablo Kesiti mm2	Civata	Ölçüler					Kutu Adet	Adet Fiyat (USD)
			D3	D2	D1	L	A		
SKPS-10-06	10	M6	6,5	4,7	6,5	27,5	10,5	800	0,341 \$
SKPS-10-08		M8	8,5	4,7	6,5	27,5	13,0	800	0,341 \$
SKPS-16-06	16	M6	6,5	5,8	7,4	30	12	500	0,448 \$
SKPS-16-08		M8	8,5	5,8	7,8	30	12	500	0,482 \$
SKPS-25-06	25	M6	6,5	7,0	9,2	40	14	350	0,775 \$
SKPS-25-08		M8	8,5	7,0	9,2	40	14	350	0,712 \$
SKPS-25-10		M10	10,5	7,0	9,5	40	14	350	0,782 \$
SKPS-35-06	35	M6	6,5	8,2	10,7	44	15,3	200	1,015 \$
SKPS-35-08		M8	8,5	8,2	10,7	44	15,3	200	0,997 \$
SKPS-35-10		M10	10,5	8,2	10,7	44	15,3	200	0,997 \$
SKPS-50-08	50	M8	8,5	10,2	12,8	52	20	150	1,549 \$
SKPS-50-10		M10	10,5	10,2	12,8	52	20	150	1,549 \$
SKPS-50-12		M12	13	10,2	12,8	52	20	150	1,597 \$
SKPS-70-08	70	M8	8,5	11,7	14,7	55	22	100	2,072 \$
SKPS-70-10		M10	10,5	11,7	14,7	55	22	100	2,072 \$
SKPS-70-12		M12	13	11,7	14,7	55	22	100	2,138 \$
SKPS-95-08	95	M8	8,5	13,6	16,7	59	26	80	2,513 \$
SKPS-95-10		M10	10,5	13,6	16,7	59	26	80	2,442 \$
SKPS-95-12		M12	13	13,6	16,7	59	26	80	2,442 \$
SKPS-120-10	120	M10	10,5	15,5	19	70	29	50	3,398 \$
SKPS-120-12		M12	13	15,5	19	70	29	50	3,320 \$
SKPS-150-10	150	M10	10,5	16,7	21	77	32	40	5,318 \$
SKPS-150-12		M12	13	16,7	21	21	32	40	5,173 \$
SKPS-185-12	185	M12	13	18,8	23	85	35	30	6,055 \$
SKPS-185-16		M16	17	18,8	23	85	35	30	5,829 \$
SKPS-240-12	240	M12	13	21,2	26	90	38,5	25	8,197 \$
SKPS-240-16		M16	17	21,2	26	90	38,5	25	8,097 \$
SKPS-300-12	300	M12	13	21,2	26	90	38,5	25	10,124 \$
SKPS-300-16		M16	17	21,2	26	90	38,5	25	10,124 \$

Bimetal(Al-Cu) SKP Kablo Pabucu

ÜRÜN KODU	KABLO KESİTİ (mm ²)	D (mm)	d±1 (mm)	L±2 (mm)	L1 (mm)	S±0,5 (mm)	Ø±0,5 (mm)	FİYAT / ADET (USD)		Delik Çapı Ø	KOLİ ADEDİ
DTL-2-16	16	16	5,5	80	38	3,5	11	2,5 \$	80	M10	480
DTL-2-25	25	16	6,5	80	38	3,5	11	2,5 \$	80	M10	480
DTL-2-35	35	16	8,2	80	38	3,5	11	2,5 \$	80	M10	480
DTL-2-50	50	20	9,7	90	43	4,5	13	3,35 \$	60	M12	360
DTL-2-70	70	20	11	90	43	4,5	13	3,35 \$	60	M12	360
DTL-2-95	95	20	12,5	90	43	4,5	13	3,35 \$	60	M12	360
DTL-2-120	120	25	14,5	114	58	5,5	13	5,15 \$	30	M12	180
DTL-2-150	150	25	16,5	114	58	5,5	13	5,15 \$	30	M12	180
DTL-2-185	185	32	17,5	124	60	6	13	7,89 \$	15	M12	90
DTL-2-240	240	32	19,5	124	60	6	13	7,89 \$	15	M12	90
DTL-2-300	300	34	23	130	60	6,5	13	11,50 \$	15	M16	90
DTL-2-400	400	40	26	155	90	7	13	16,90 \$	5	M16	50

Teknik Özellikler
İletken Malzeme

Malzeme : %99.9 Aliminyum ve Bakır
 Çekme Derecesi : 110Mpa
 Çalışma Sıcaklığı : -40°C --- +100°C

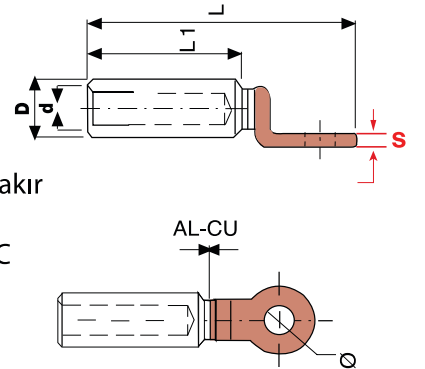

Bakır Alüminyumlu SKP (Bimetalik Uzun Tip)



ÜRÜN KODU	KABLO KESİTİ (mm ²)	D (mm)	d (mm)	L±1 (mm)	L1 (mm)	L2 (mm)	L3 (mm)	W (mm)	S (mm)	Ø (mm)	KUTU ADEDİ	FIYAT/ADET (USD)
CAL-16C	16	16	5,5	82	38	50	14	14	3,2	8,5	80	3,18 \$
CAL-25C	25	16	6,5	82	38	50	14	14	3,2	8,5	80	3,18 \$
CAL-35C	35	16	8,2	82	38	50	14	14	3,2	8,5	80	3,18 \$
CAL-50C	50	20	9,7	94	43	55	16	16	5	8,5	60	4,50 \$
CAL-70C	70	20	11	94	43	55	16	16	5	8,5	60	4,50 \$
CAL-95C	95	20	12,5	94	43	55	16	16	5	8,5	60	4,50 \$
CAL-120 C	120	25	14,5	120	60	72	32	23	6,5	10,5	30	7,50 \$
CAL-150 C	150	25	16,5	120	60	72	32	23	6,5	10,5	30	7,50 \$
CAL-185 C	185	32	17,5	133	60	73	38	23	8	12,5	15	12,25 \$
CAL-240 C	240	32	19,5	133	60	73	38	29	8	12,5	15	12,25 \$

Bimetalik Ek Muf (Pinli)

ÜRÜN KODU	KABLO KESİTİ (mm ²)	D (mm)	D1 (mm)	d (mm)	L (mm)	L1 (mm)	KUTU ADEDİ	FIYAT/ADET \$
CTL-10	10	6	12	5	58	30	220	3,10 \$
CTL-16	16	6	12	5,5	58	30	220	3,10 \$
CTL-25	25	6	12	7	58	30	200	3,10 \$
CTL-35	35	7	14	8,2	70	40	140	3,38 \$
CTL-50	50	8	16	10	74	40	100	3,80 \$
CTL-70	70	10	18	11,5	88	45	60	4,45 \$
CTL-95	95	12	23	13	94	45	40	6,00 \$
CTL-120	120	12	23	14,8	97	45	40	8,00 \$

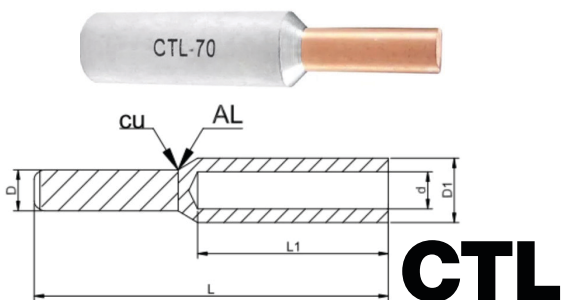

CAL

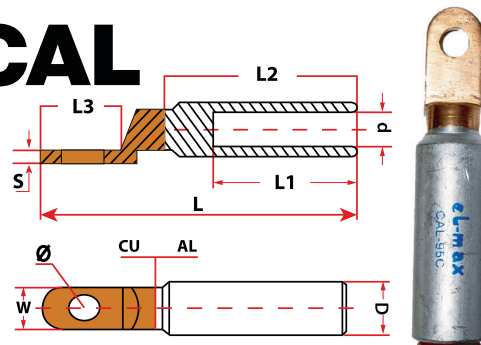

Alüminyum-Bakır Ek-Muf

ÜRÜN KODU	$d2\pm0.2$	$D2\pm0.2$	$d1\pm0.2$	$D1\pm0.2$	$L1\pm1$	$L2\pm1$	$L\pm2$	Kutu Adedi	FIYAT/ADET \$
GTL-16	5.5	9	6	10	32	20	69	160	1,66\$
GTL-25	6	10	7	12	34	23	74	200	2,00\$
GTL-35	7	11	8.5	13	35	26	80	120	2,44\$
GTL-50	8.5	12	9.7	15	40	27	85	70	3,22\$
GTL-70	9.7	14	11.5	18	43	33	95	40	3,77\$
GTL-95	11.5	16	13.5	20	45	35	101	40	5,33\$
GTL-120	13.5	19	15	23	50	40	112	40	6,66\$
GTL-150	15	21	16.5	24	53	40	116	30	8,55\$
GTL-185	16.5	23	18.5	27	58	44	122	20	11,88\$
GTL-240	18.5	25	21	30	58	45	128	10	12,70\$

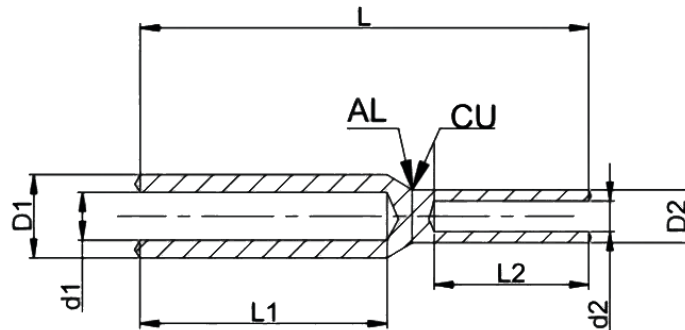

GTL

Topraklama Klemensleri

Pano Topraklama Klemensleri (6x8 mm Kesit 63 Amp.)

Teknik Özellikler

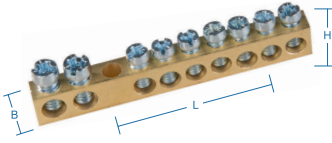

ÜRÜN KODU	AÇIKLAMA	L	B	H	KOLİ ADEDİ	FİYAT
1004	4 Delikli Topraklama Klemensi	33	6	8	1500	22,5 ₺
1005	5 Delikli Topraklama Klemensi	38	6	8	1500	24,75 ₺
1006	6 Delikli Topraklama Klemensi	45	6	8	1250	30,75 ₺
1007	7 Delikli Topraklama Klemensi	50	6	8	1000	33,75 ₺
1009	9 Delikli Topraklama Klemensi	62	6	8	1000	38,25 ₺
1010	10 Delikli Topraklama Klemensi	68	6	8	750	47,25 ₺
1012	12 Delikli Topraklama Klemensi	80	6	8	750	57,00 ₺

Pano Topraklama Klemensleri Ayaklı (6,5x9 mm Kesit 80 Amp.)

Teknik Özellikler

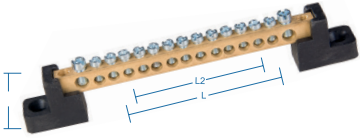

ÜRÜN KODU	AÇIKLAMA	L	L2	H	KOLİ ADEDİ	FİYAT
1106	6 Delikli Topraklama Klemensi	85	70	22	200	54 ₺
1107	7 Delikli Topraklama Klemensi	90	75	22	200	60 ₺
1110	10 Delikli Topraklama Klemensi	108	95	22	150	72 ₺
1112	12 Delikli Topraklama Klemensi	120	106	22	150	76,5 ₺
1115	15 Delikli Topraklama Klemensi	138	124	22	125	92,25 ₺
1120	20 Delikli Topraklama Klemensi	165	152	22	100	121,5 ₺
1125	25 Delikli Topraklama Klemensi	195	180	22	75	162 ₺
1130	30 Delikli Topraklama Klemensi	235	220	22	75	231 ₺

Dađıtım Ünitesi

1 Kutuplu Dađıtım Ünitesi Ray Geçmeli Kapaklı (7x12 mm 125 Amp)

Teknik Özellikler

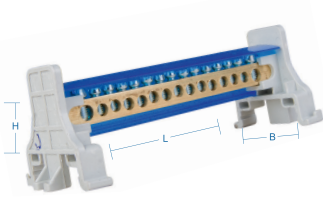

ÜRÜN KODU	AÇIKLAMA	L	B	H	KOLİ ADEDİ	FİYAT
2007	2 + 5 7 DELİKLİ ÜNİTE	76	44	42	70	129 ₺
2010	2 + 8 10 DELİKLİ ÜNİTE	100	44	42	60	150 ₺
2012	2 + 10 12 DELİKLİ ÜNİTE	115	44	42	55	172,5 ₺
2015	2 + 13 15 DELİKLİ ÜNİTE	135	44	42	45	217,5 ₺
2020	2 + 18 20 DELİKLİ ÜNİTE	170	44	42	35	270 ₺
2022	2 + 20 22 DELİKLİ ÜNİTE	185	44	42	30	300 ₺
2025	2 + 23 25 DELİKLİ ÜNİTE	207	44	42	25	345 ₺
2030	2 + 28 30 DELİKLİ ÜNİTE	245	44	42	25	397,5 ₺

2 Kutuplu Dađıtım Ünitesi (7x12 mm 125 Amp)

Teknik Özellikler

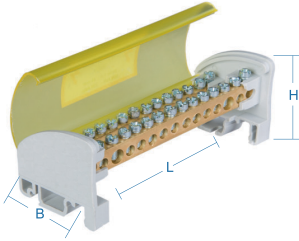

ÜRÜN KODU	AÇIKLAMA	L	B	H	KOLİ ADEDİ	FİYAT
1407	2 + 5 7 DELİKLİ DAĐITIM ÜNİTESİ	65	45	47	22	262,5 ₺
1410	2 + 8 10 DELİKLİ DAĐITIM ÜNİTESİ	88	45	47	15	285 ₺
1412	2 + 10 12 DELİKLİ DAĐITIM ÜNİTESİ	102	45	47	14	315 ₺
1415	2 + 13 15 DELİKLİ DAĐITIM ÜNİTESİ	126	45	47	12	405 ₺
1420	2 + 18 20 DELİKLİ DAĐITIM ÜNİTESİ	162	45	47	6	510 ₺
1422	2 + 20 22 DELİKLİ DAĐITIM ÜNİTESİ	175	45	47	6	555 ₺

4 Kutuplu Dađıtım Ünitesi (7x12 mm 125 Amp)

Teknik Özellikler

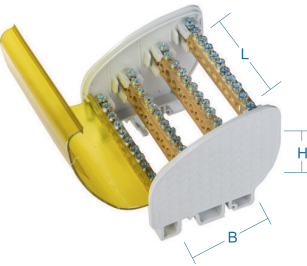

ÜRÜN KODU	AÇIKLAMA	L	B	H	KOLİ ADEDİ	FİYAT
1507	2 + 5 7 DELİKLİ DAĐITIM ÜNİTESİ	60	80	75	10	495 ₺
1510	2 + 8 10 DELİKLİ DAĐITIM ÜNİTESİ	83	80	75	8	535,5 ₺
1512	2 + 10 12 DELİKLİ DAĐITIM ÜNİTESİ	97	80	75	6	592,5 ₺
1515	2 + 13 15 DELİKLİ DAĐITIM ÜNİTESİ	120	80	75	5	735 ₺
1520	2 + 18 20 DELİKLİ DAĐITIM ÜNİTESİ	155	80	75	4	957 ₺
1522	2 + 20 22 DELİKLİ DAĐITIM ÜNİTESİ	170	80	75	4	1020 ₺
1525	2 + 23 25 DELİKLİ DAĐITIM ÜNİTESİ	191	80	75	4	1177,5 ₺

Dađıtım Ünitesi

4 Kutuplu 10x15 Kesit 160 AMP Dađıtıcı Üniteler (Ayak Geçmeli) Alçak Model

Teknik Özellikler

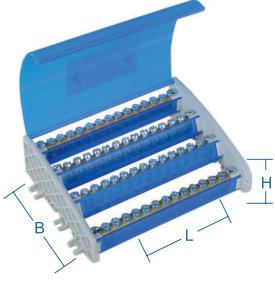

ÜRÜN KODU	AÇIKLAMA	L	B	H	KOLİ ADEDİ	FİYAT
3207	2 + 5 7 DELİKLİ ÜNİTE	105	144	55	12	900 ₺
3210	2 + 8 10 DELİKLİ ÜNİTE	145	144	55	8	1327,5 ₺
3212	2 + 10 12 DELİKLİ ÜNİTE	165	144	55	8	1500 ₺
3215	2 + 13 15 DELİKLİ ÜNİTE	200	144	55	6	1950 ₺
3220	2 + 18 20 DELİKLİ ÜNİTE	255	144	55	4	2535 ₺
3222	2 + 20 22 DELİKLİ ÜNİTE	275	144	55	4	2625 ₺

5 Kutuplu 10x15 Kesit 160 AMP Dađıtıcı Üniteler Yüksek Model

Teknik Özellikler

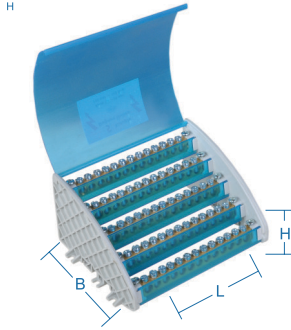







ÜRÜN KODU	AÇIKLAMA	L	B	H	KOLİ ADEDİ	FİYAT
3307	2 + 5 7 DELİKLİ DAĐITIM ÜNİTESİ	105	151	95	8	1102,5 ₺
3310	2 + 8 10 DELİKLİ DAĐITIM ÜNİTESİ	145	151	95	4	1500 ₺
3312	2 + 10 12 DELİKLİ DAĐITIM ÜNİTESİ	165	151	95	4	1800 ₺
3315	2 + 13 15 DELİKLİ DAĐITIM ÜNİTESİ	200	151	95	4	2,250 ₺
3320	2 + 18 20 DELİKLİ DAĐITIM ÜNİTESİ	255	151	95	4	3000 ₺
3322	2 + 20 22 DELİKLİ DAĐITIM ÜNİTESİ	275	151	95	4	3300 ₺

Buat Klemensler

Geçmeli Buat Klemensler



Teknik Özellikler





	ÜRÜN KODU	KABLO KESİTİ	EN	BOY	YÜKSEKLİK	KOLİ / KUTU	FİYAT
	ELX2.5-2	0.5-2.5 mm ²	9,9	16,4	6	10.000	200 0,093 \$
	ELX2.5-3	0.5-2.5 mm ²	13,9	16,4	6	10.000	200 0,112 \$
	ELX2.5-4	0.5-2.5 mm ²	17,9	16,4	6	5000	100 0,131 \$
	ELX2.5-5	0.5-2.5 mm ²	21,9	16,4	6	5000	100 0,152 \$
	ELX2.5-6	0.5-2.5 mm ²	13,9	16,4	11,5	5000	100 0,191 \$
	ELX2.5-8	0.5-2.5 mm ²	17,9	16,4	11,5	5000	50 0,233 \$

Tırnaklı Çok Amaçlı Klemensler



Gövde PC
Halogen FREE

Teknik Özellikler

	ÜRÜN KODU	KABLO KESİTİ	AÇIKLAMA	KOLİ / KUTU	FİYAT
	ELX-412	0.14-4 mm ²	2 İletken Bağlantılı	5000	100 0,192 \$
	ELX-413	0.14-4 mm ²	3 İletken Bağlantılı	5000	100 0,257 \$
	ELX-414	0.14-4 mm ²	4 İletken Bağlantılı	2500	100 0,314 \$
	ELX-415	0.14-4 mm ²	5 İletken Bağlantılı	2500	50 0,374 \$

Çalışma Sıcaklığı : -40°C +105°C Nominal Akım : 32A Nominal Gerilim : 450V

Plastik Kablo Bađları (Siyah - Beyaz)



ÜRÜN KODU	BOYUTLAR		KOLİ ADEDİ	P. MİKTARI	AÇIKLAMA	FİYAT
	En (mm)	Uzunluk (mm)				
ELX KB 2,5 x 100	2,5	100	60.000	100	Plastik Kablo Bađı	0,251 ₺
ELX KB 2,5 x 140	2,5	140	35.000	100	Plastik Kablo Bađı	0,374 ₺
ELX KB 2,5 x 200	2,5	200	25.000	100	Plastik Kablo Bađı	0,540 ₺
ELX KB 3,6 x 150	3,6	150	25.000	100	Plastik Kablo Bađı	0,639 ₺
ELX KB 3,6 x 205	3,6	205	20.000	100	Plastik Kablo Bađı	0,871 ₺
ELX KB 3,6 x 250	3,6	250	20.000	100	Plastik Kablo Bađı	1,027 ₺
ELX KB 3,6 x 300	3,6	300	15.000	100	Plastik Kablo Bađı	1,302 ₺
ELX KB 3,6 x 370	3,6	370	12.000	100	Plastik Kablo Bađı	1,643 ₺
ELX KB 4,8 x 200	4,8	200	12.000	100	Plastik Kablo Bađı	1,264 ₺
ELX KB 4,8 x 250	4,8	250	12.000	100	Plastik Kablo Bađı	1,473 ₺
ELX KB 4,8 x 300	4,8	300	11.000	100	Plastik Kablo Bađı	1,851 ₺
ELX KB 4,8 x 350	4,8	350	9.000	100	Plastik Kablo Bađı	2,145 ₺
ELX KB 4,8 x 400	4,8	400	8.000	100	Plastik Kablo Bađı	2,439 ₺
ELX KB 4,8 x 450	4,8	450	6.000	100	Plastik Kablo Bađı	2,903 ₺
ELX KB 8 x 250	8	250	6.000	100	Plastik Kablo Bađı	2,945 ₺
ELX KB 8 x 300	8	300	5.000	100	Plastik Kablo Bađı	3,911 ₺
ELX KB 8 x 380	8	380	5.000	100	Plastik Kablo Bađı	4,209 ₺
ELX KB 8 x 450	8	450	3.500	100	Plastik Kablo Bađı	4,711 ₺
ELX KB 8 x 550	8	550	3.000	100	Plastik Kablo Bađı	6,312 ₺
ELX KB 8 x 750	8	750	2.000	100	Plastik Kablo Bađı	10,095 ₺
ELX KB 9 x 762	9	762	1.500	100	Plastik Kablo Bađı	13,462 ₺
ELX KB 9 x 940	9	940	1.500	100	Plastik Kablo Bađı	15,559 ₺

Yapışkanlı Kroşeler

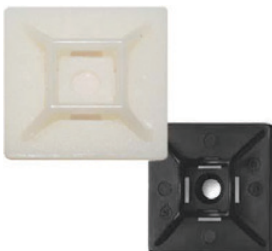

Teknik Özellikler

ÜRÜN KODU	RENK	ÖLÇÜ	K. ADEDİ	AÇIKLAMA	FİYAT
ELX YK20	Beyaz	20 x 20	100	Yapışkanlı Kroşe	1,51 ₺
ELX YK28	Beyaz	28 x 28	100	Yapışkanlı Kroşe	2,545 ₺

Ayak Pedalları

KB 2

 Araç Lift Kumanda
Çift Kontaklı

FİYAT: 11,90 \$

ÜRÜN KODU	KB-2
AÇIKLAMA	Lift Kumanda 2'li Tek Hızlı Çift Kontaklı 10A
KUTU ADEDİ	1 Adet

AP-9

 Ayak Pedalları
Kablosuz

FİYAT: 33,6 \$

ÜRÜN KODU	ELX-FSMS/1
KONTAK TİPİ	1NO+1NC
AÇIKLAMA	Döküm Korumalı Kapaklı Pedal Kablosuz
KUTU ADEDİ	1 Adet

AP-9

 Ayak Pedalları
2 mt Kablolü

FİYAT: 37,0 \$

ÜRÜN KODU	ELX-FSMS/1
KONTAK TİPİ	1NO+1NC
AÇIKLAMA	Döküm Korumalı Kapaklı Pedal 2 m Kablolü
KUTU ADEDİ	1 Adet

FS-1 METAL

Ayak Pedalları

FİYAT: 6,85 \$

ÜRÜN KODU	FS-1-AP1
KONTAK TİPİ	1NO+1NC
AÇIKLAMA	2 METRE Kablolü Metal Pedal
KUTU ADEDİ	1 Adet

FS-2 METAL

Ayak Pedalları

FİYAT: 8,28 \$

ÜRÜN KODU	FS-2-AP2
KONTAK TİPİ	1NO+1NC
AÇIKLAMA	Kablolü 1 mt Döküm Pedal
KUTU ADEDİ	1 Adet

FS-3 METAL

Ayak Pedalları

FİYAT: 11,44 \$

ÜRÜN KODU	FS-3-AP3
KONTAK TİPİ	1NO+1NC
AÇIKLAMA	Kablolü 1 mt Döküm Pedal
KUTU ADEDİ	1 Adet

Vinç Kumanda Butonları

COB61

Mekanik Kilitli
Tek Hızlı

FİYAT: 4,0 \$



ÜRÜN KODU	COB61-VK2
AÇIKLAMA	Tek Hızlı 2'li Vinç Kumanda Mekanik Kilitli Kontakt 5A
KUTU ADEDİ	1 Adet

COB62

Mekanik Kilitli
Tek Hızlı

FİYAT: 5,25 \$



ÜRÜN KODU	COB62-VK4
AÇIKLAMA	Tek Hızlı 4'lü Vinç Kumanda Mekanik Kilitli Kontakt 5A
KUTU ADEDİ	1 Adet

COB63

Mekanik Kilitli
Tek Hızlı

FİYAT: 6,875 \$



ÜRÜN KODU	COB63-VK6
AÇIKLAMA	Tek Hızlı 6'lı Vinç Kumanda Mekanik Kilitli Kontakt 5A
KUTU ADEDİ	1 Adet

COB64

Mekanik Kilitli
Tek Hızlı

FİYAT: 9.375 \$



ÜRÜN KODU	COB64-VK8
AÇIKLAMA	Tek Hızlı 8'li Vinç Kumanda Mekanik Kilitli Kontakt 5A
KUTU ADEDİ	1 Adet

COBC1

Mekanik Kilitli - Tek
Hızlı - Faz Bağlantı
Köprülü

FİYAT: 16,25 \$



ÜRÜN KODU	COBC1-VKB3
AÇIKLAMA	Tek Hızlı 2 + Acil Stop Vinç Ku- manda Mekanik Kilitli Kontakt 16A
KUTU ADEDİ	1 Adet

COBC2

Mekanik Kilitli - Tek
Hızlı - Faz Bağlantı
Köprülü

FİYAT: 22,50 \$



ÜRÜN KODU	COBC2-VKB5
AÇIKLAMA	Tek Hızlı 4 + Acil Stop Vinç Ku- manda Mekanik Kilitli Kontakt 16A
KUTU ADEDİ	1 Adet

COBC3

Mekanik Kilitli - Tek
Hızlı - Faz Bağlantı
Köprülü

FİYAT: 29,37 \$



ÜRÜN KODU	COBC3-VKB7
AÇIKLAMA	Tek Hızlı 6 + Acil Stop Vinç Ku- manda Mekanik Kilitli Kontakt 16A
KUTU ADEDİ	1 Adet

COBC4

Mekanik Kilitli - Tek
Hızlı - Faz Bağlantı
Köprülü

FİYAT: 35,00 \$



ÜRÜN KODU	COBC4-VKB8
AÇIKLAMA	Tek Hızlı 8 + Acil Stop Vinç Ku- manda Mekanik Kilitli Kontakt 16A
KUTU ADEDİ	1 Adet

Klemens Grubu

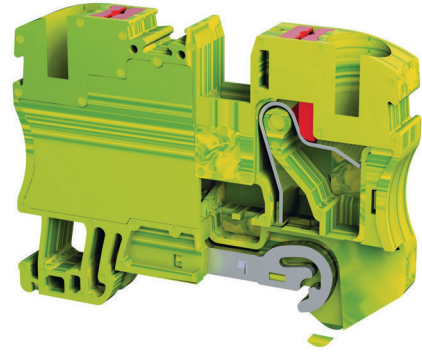
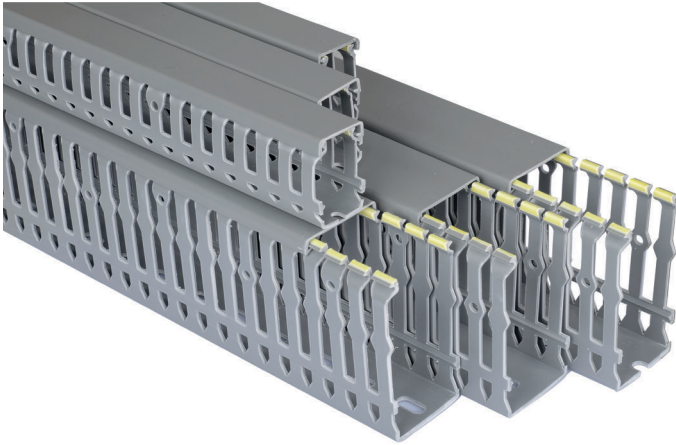
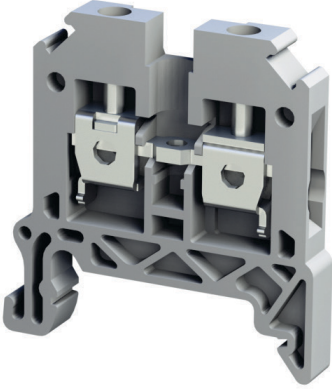
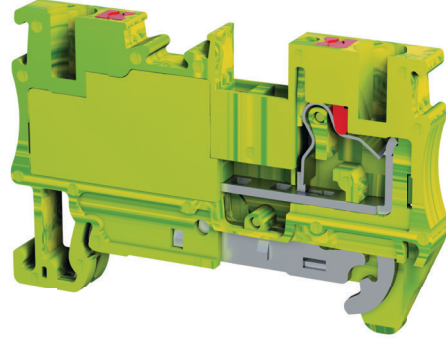
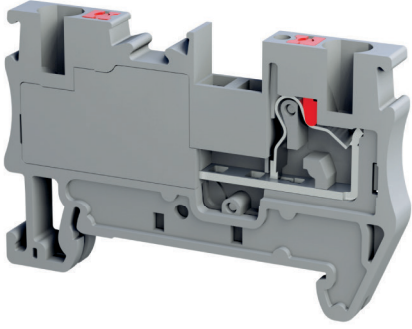

KLEMENS AKSESUAR

FİYAT SORUNUZ

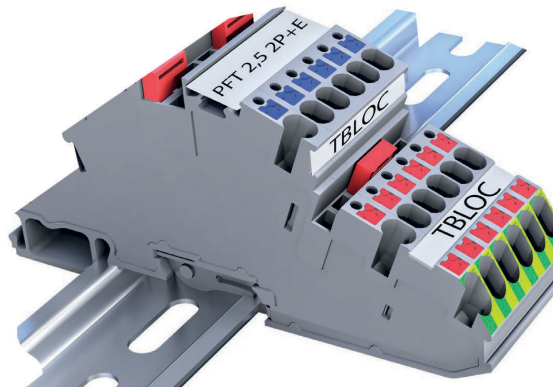

Kontaktör

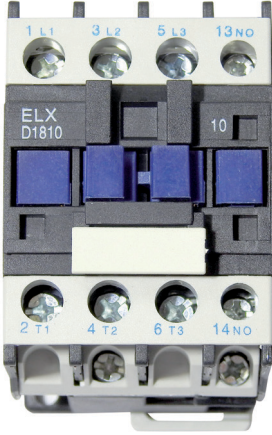

ELX-D SERİSİ 3 FAZLI KONTAKTÖR 24 V

ÜRÜN KODU	ANMA AKIMI (A)	ANMA GÜCÜ (kW) 50/60Hz	YARDIMCI KONTAK	K. ADEDİ	FİYAT
ELX-D2510	25 A	11 kW	1NO	50	18,00
ELX-D3210	32 A	15 kW	1NO	50	23,88
ELX-D4011	40 A	18,5 kW	1NO+1NC	50	45,00

3 Fazlı Kontaktör UNMC Serisi

Teknik Özellikler

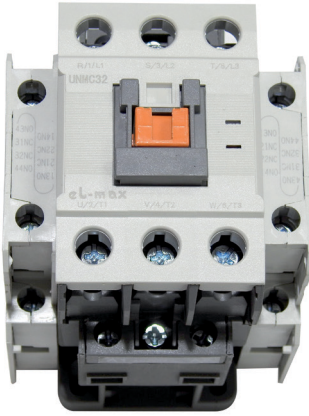

ÜRÜN KODU	ANMA AKIMI (A)	ANMA GÜCÜ (kW) 50/60Hz	YARDIMCI KONTAK	K. ADEDİ	FİYAT
UNMC-12	12 A	5,5 kW	1NO+1NC	50	14,00 \$
UNMC-18	18 A	7,5 kW	1NO+1NC	50	18,80 \$
UNMC-22	22 A	11 kW	1NO+1NC	50	19,50 \$
UNMC-32	32 A	15 kW	2NO+2NC	40	32,75 \$
UNMC-40	40 A	18,5 kW	2NO+2NC	40	33,75 \$
UNMC-65	65 A	30 kW	2NO+2NC	20	58,00 \$
UNMC-85	85 A	45 kW	2NO+2NC	20	88,00 \$

Kontaktör

3 Fazlı Kontaktör ELX-D Serisi

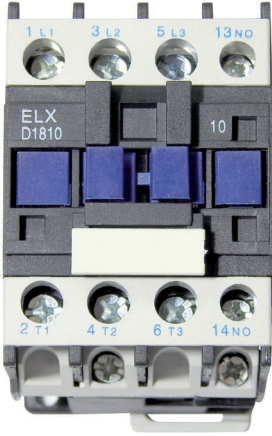

Teknik Özellikler

ÜRÜN KODU	ANMA AKIMI (A)	ANMA GÜCÜ (kW) 50/60Hz	YARDIMCI KONTAK	K. ADEDİ	FİYAT
ELX-D0910	9 A	4 kW	1NO	50	10,55 \$
ELX-D0901	9 A	4 kW	1NC	50	10,55 \$
ELX-D1210	12 A	5,5 kW	1NO	50	10,83 \$
ELX-D1201	12 A	5,5 kW	1NC	50	10,83 \$
ELX-D1810	18 A	7,5 kW	1NO	50	12,77 \$
ELX-D1801	18 A	7,5 kW	1NC	50	12,77 \$
ELX-D2510	25 A	11 kW	1NO	50	18,00 \$
ELX-D2501	25 A	11 kW	1NC	50	18,00 \$
ELX-D3210	32 A	15 kW	1NO	50	23,88 \$



Teknik Özellikler

ÜRÜN KODU	ANMA AKIMI (A)	ANMA GÜCÜ (kW) 50/60Hz	K. ADEDİ	FİYAT
ELX-D115	115 A	55 kW	4	153,00 \$
ELX-D150	150 A	75 kW	4	162,00 \$
ELX-D170	170 A	90 kW	4	219,00 \$

Yardımcı Kontak Blođu



Teknik Özellikler

ÜRÜN KODU	BİRLİKTE KULLANILDIđI KONTAKTÖR	YARDIMCI KONTAK	MONTAJ ŞEKLİ	FİYAT
LAD-8N11	ELX-D115 - ELX-D170	1NO+1NC	YAN	10,60 \$

Yardımcı Kontak Blokları

UNMC Serisi Yardımcı Kontak Blođu



Teknik Özellikler

ÜRÜN KODU	BİRLİKTE KULLANILDIĐI KONTAKTÖR	YARDIMCI KONTAK	MONTAJ ŞEKLİ	FİYAT
AU-2	UNMC-9-UNMC-40	1NO+1NC	ÜST	3,76 \$
AU-4	UNMC-9-UNMC-40	2NO+2NC	ÜST	6,25 \$

ELX-D Serisi Yardımcı Kontak Blođu



Teknik Özellikler

ÜRÜN KODU	BİRLİKTE KULLANILDIĐI KONTAKTÖR	YARDIMCI KONTAK	MONTAJ ŞEKLİ	FİYAT
ELXDN11	ELX-D0910-ELX-D3210	1NO+1NC	ÜST	3,75 \$
ELXDN22	ELX-D0910-ELX-D3210	2NO+2NC	ÜST	6,25 \$

Mini Kontaktör İçin Termik Röle



Teknik Özellikler

ÜRÜN KODU	TERMİK AYAR SAHASI (A)	ANMA AKIMI (A)	K. ADEDİ	FİYAT
UNTR-MK-6	4-6 A	6 A	100	11,42 \$

Sessiz Kontaktör (Aydınlatma Kontaktörü)



Teknik Özellikler

ÜRÜN KODU	ANMA AKIMI AC-3 (A)	KUTUP	YARDIMCI KONTAK	K. ADEDİ	FİYAT
ELX-2P-25A	25 A	2	2NO	100	14,38 \$

Darbe Akım Anahtarı



Teknik Özellikler

ÜRÜN KODU	ANMA AKIMI	K. ADEDİ	FİYAT
EDA-16	16 A	240	14,30 \$

Termik Röleler

UNMR Serisi Termik Röle

Teknik Özellikler

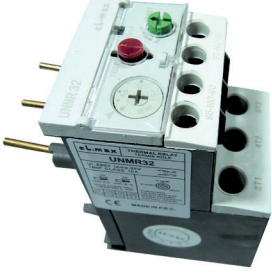

ÜRÜN KODU	ANMA AKIMI (A)	TERMİK AYAR SAHASI	K. ADEDİ	FİYAT
UNMR-32-10	10 A	7-10 A	50	13,00 \$
UNMR-32-13	13 A	9-13 A	50	13,00 \$
UNMR-32-18	18 A	13-18 A	20	13,00 \$
UNMR-32-25	25 A	17-25 A	20	13,00 \$
UNMR-32-32	32 A	23-32 A	20	15,60 \$
UNMR-85-65	65 A	45-65 A	20	22,00 \$
UNMR-85-85	85 A	63-85 A	20	22,00 \$

ELX-D Serisi Termik Röle

Teknik Özellikler



ÜRÜN KODU	ANMA AKIMI (A)	TERMİK AYAR SAHASI	K. ADEDİ	FİYAT
UNTR1-D13-2,5	2,5 A	1,6-2,5 A	50	10,80 \$
UNTR1-D13-4	4 A	2,5-4 A	50	10,80 \$
UNTR1-D13-6	6 A	4-6 A	50	10,80 \$
UNTR1-D13-8	8 A	5-8 A	50	10,80 \$
UNTR1-D13-10	10 A	7-10 A	50	10,80 \$
UNTR1-D13-13	13 A	9-13 A	50	10,80 \$
UNTR1-D13-18	18 A	12-18 A	50	10,80 \$
UNTR1-D13-25	25 A	17-25 A	50	10,80 \$
UNTR1-D13-32	32 A	23-32 A	50	10,80 \$

Raya Montaj Termik Röle

Teknik Özellikler



ÜRÜN KODU	ANMA AKIMI (A)	TERMİK AYAR SAHASI	K. ADEDİ	FİYAT
UNSRI-D59-4	4 A	2,5-4 A	50	16,00 \$
UNSRI-D59-6,3	6,3 A	4-6,3 A	50	16,00 \$
UNSRI-D59-10	10 A	6,3-10 A	50	16,00 \$
UNSRI-D59-16	16 A	10-16 A	50	16,00 \$
UNSRI-D59-25	25 A	16-25 A	50	19,00 \$
UNSRI-D59-40	40 A	25-40 A	50	19,00 \$
UNSRI-D59-57	57 A	40-57 A	50	19,00 \$
UNSRI-D59-63	63 A	57-63 A	50	19,00 \$



**ASANSÖR GRUBU
MALZEMELERİ**

Asansör Panosu EMC Filtre

ELX-ASP

Asansör Panosu

- * Asansör Panosu OAG
- * Asansör Panosu HİMEL
- * Asansör Panosu GENERAL
- * Asansör Panosu MAKEL
- * Asansör Panosu SCHNEIDER

**PANOLARIMIZ
6x40 PAKO
ŞALTERLİDİR.**

FİYAT SORUNUZ



ELX-30-EMC

EMC Filtre 30 Amper

FİYAT SORUNUZ



Çalışma Voltajı : 400V
Çalışma Frekansı : 0 - 50 Hz
Çalışma Akımı : 30A
Çalışma Sıcaklığı : -20 C / +80 C

ELX-FD

Frenleme Direnci

FİYAT SORUNUZ

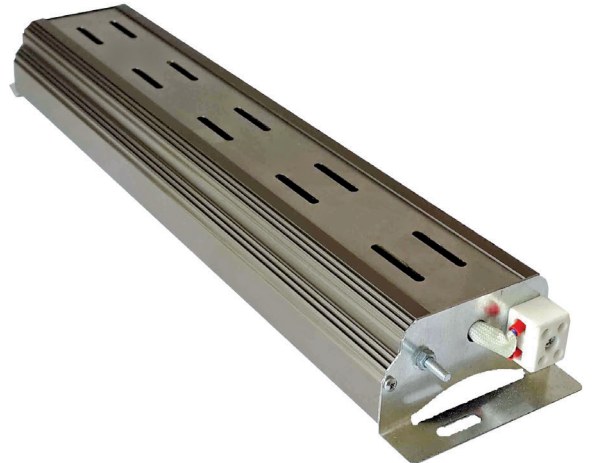

24 V Güç Kaynakları



15 W Güç Kaynađı

FİYAT: 10,84 \$

ÜRÜN KODU	ELX-TR-24-15
GÜÇ	15 W
AÇIKLAMA	Güç Kaynađı
AKIM	0.6 A
KUTU ADEDİ	60 Adet

25 W Güç Kaynađı

FİYAT: 12,50 \$

ÜRÜN KODU	ELX-TR-24-25
GÜÇ	25 W
AÇIKLAMA	Güç Kaynađı
AKIM	1.0 A
KUTU ADEDİ	60 Adet

60 W Güç Kaynađı

FİYAT: 18,00 \$

ÜRÜN KODU	ELX-TR-24-60
GÜÇ	60 W
AÇIKLAMA	Güç Kaynađı
AKIM	2.5 A
KUTU ADEDİ	60 Adet

120 W Güç Kaynađı

FİYAT: 23,00 \$

ÜRÜN KODU	ELX-TR-24-120
GÜÇ	120 W
AÇIKLAMA	Güç Kaynađı
AKIM	5 A
KUTU ADEDİ	60 Adet

200 W Güç Kaynađı

FİYAT: 31,00 \$

ÜRÜN KODU	ELX-TR-24-200
GÜÇ	200 W
AÇIKLAMA	Güç Kaynađı
AKIM	8.5 A
KUTU ADEDİ	60 Adet

250 W Güç Kaynađı

FİYAT: 39,50 \$

ÜRÜN KODU	ELX-TR-24-250
GÜÇ	250 W
AÇIKLAMA	Güç Kaynađı
AKIM	10 A
KUTU ADEDİ	36 Adet

350 W Güç Kaynađı

FİYAT: 46,50 \$

ÜRÜN KODU	ELX-TR-24-350
GÜÇ	350 W
AÇIKLAMA	Güç Kaynađı
AKIM	15 A
KUTU ADEDİ	36 Adet

500 W Güç Kaynađı

FİYAT: 61,00 \$

ÜRÜN KODU	ELX-TR-24-500
GÜÇ	500 W
AÇIKLAMA	Güç Kaynađı
AKIM	20 A
KUTU ADEDİ	36 Adet

600 W Güç Kaynađı

FİYAT: 97,00 \$

ÜRÜN KODU	ELX-TR-24-600
GÜÇ	600 W
AÇIKLAMA	Güç Kaynađı
AKIM	25 A
KUTU ADEDİ	36 Adet

IP:20
24 V

Asansör Grubu Malzemeleri

ELX-PS

Pako Şalter

FİYAT SORUNUZ

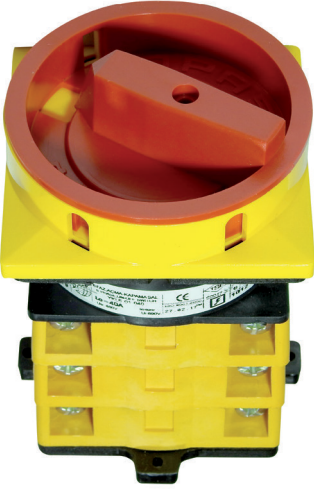

BY-PASS

Şalter

FİYAT SORUNUZ



Ray Montaj Pako Şalter

FİYAT SORUNUZ

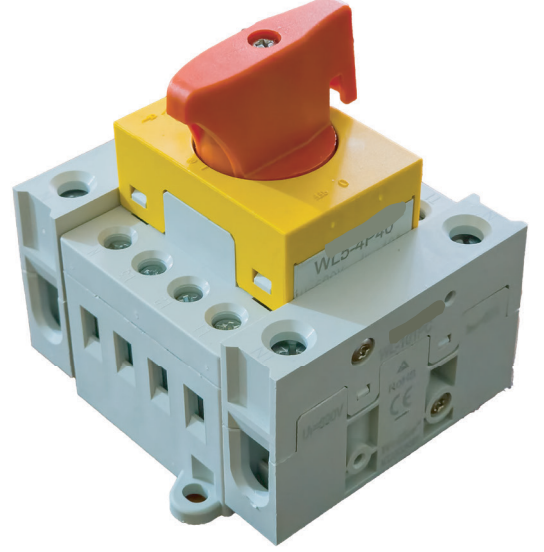

NEMLİYER GRUBU

FİYAT SORUNUZ



PTC'li Faz Koruma Rölesi

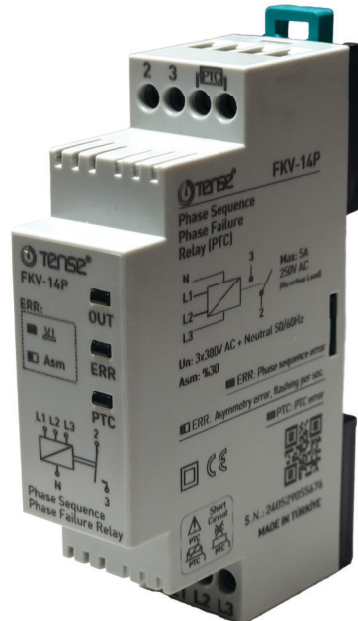

Asansör Grubu Malzemeleri

ELX-STA

Mono Stabil/ Bi Stabil / Silver Mono Stabil

FİYAT SORUNUZ



- 1,5 mt. Kablolu
- Mono Stable
- Bi Stable

OTOMAT RAYI

Ray Taşıyıcı

FİYAT SORUNUZ



NÜVE

FİYAT SORUNUZ



Asansör Grubu Malzemeleri

RAYA Montaj Pano Prizi

FİYAT SORUNUZ



TRAFO Asansör Güç Trafosu

FİYAT SORUNUZ



Kapı Switchleri Door Switch



1x16 Amper Pano Prizi

FİYAT SORUNUZ



Asansör Grubu Malzemeleri

Mıknatıslar



Teknik Özellikler

ÜRÜN KODU	K. ADEDİ	AÇIKLAMA	FİYAT
22 x 7	1500	22 mm Çap, 7 mm Yükseklik Kırmızı Boyalı Yuvarlak Mıknatıs	0,125 \$
10 cm Şerit Mıknatıs	360	20 mm en, 8 mm Yükseklik, Şerit Mıknatıs	0,69 \$
30 cm Şerit Mıknatıs	120	20 mm en , 8 mm Yükseklik, Şerit Mıknatıs	1,69 \$

Aküler / AGM Kuru Tip Akü



Teknik Özellikler

ÜRÜN KODU	K. ADEDİ	AÇIKLAMA	FİYAT
EL 12 1.3	20	12V 1.3Ah/20hr	Sorunuz
EL 12 7	10	12V 7Ah/20hr	Sorunuz
EL 12 9	8	12V 9Ah/20hr	Sorunuz

Köprü Diyot



Teknik Özellikler

ÜRÜN KODU	AKIM	AÇIKLAMA	K. ADEDİ	FİYAT
KD-35	35 AMPER	Köprü Diyot	50	1,28 \$
KD-50	50 AMPER	Köprü Diyot	50	2,10 \$

Mini Anahtarlar

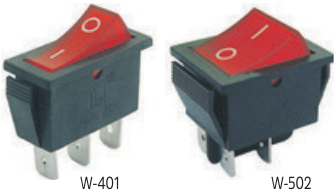

Teknik Özellikler

FİYAT SORUNUZ

ÜRÜN KODU	AYAK SAYISI	YÜK GERİLİMİ	AÇIKLAMA	FONKSİYON	ÖLÇÜ
W-401	3 Pin	6 A / 250 VAC	Işıklı Dar Tip	ON-OFF	28,5 x 10,5
W-502	4 Pin	6 A / 250 VAC	Işıklı Geniş Tip	ON-OFF	28,5 x 20

Deprem Sensörü

Duman Dedektörü

ELX-DS

Deprem Sensörü

FİYAT SORUNUZ

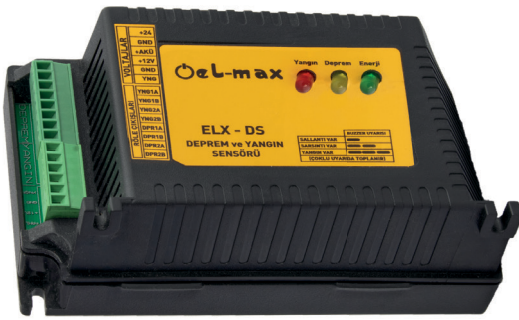

ELX-DD-12

Duman Dedektörü
12 Volt DC

FİYAT SORUNUZ



Intercom Systems



Enerji Kabloları



Cu
Bakır



Al
Alüminyum

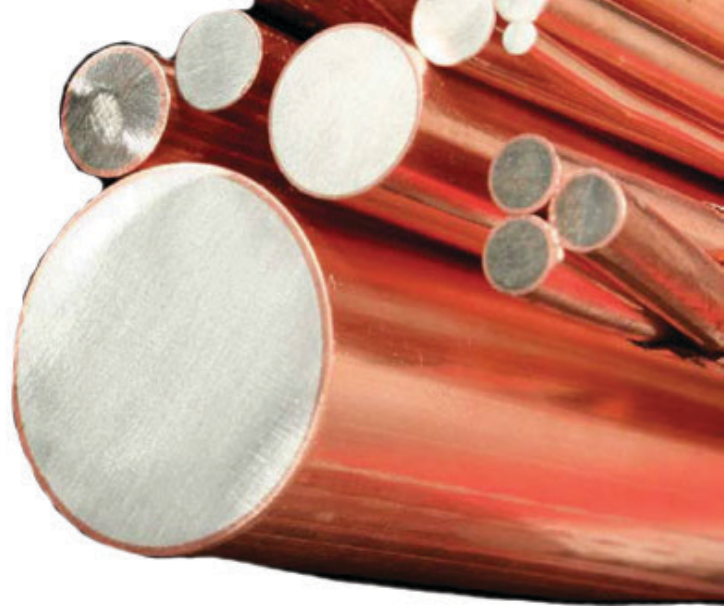

CCA BAKIR ALÜMİNYUM KARIŞIK

Blendajlı Kablo
Çok Damarlı (NYAF) Kablo
TTR KABLO
Kumanda Kablosu
Tek Damarlı (NYA) Kablo
Çeşitli Renk Seçenekleri



Enerji Kabloları



ELX-DT13

DT 13 Dijital Kablo - Telefon Kabloları

FİYAT SORUNUZ

Yassı Flexible / Flat Flexible

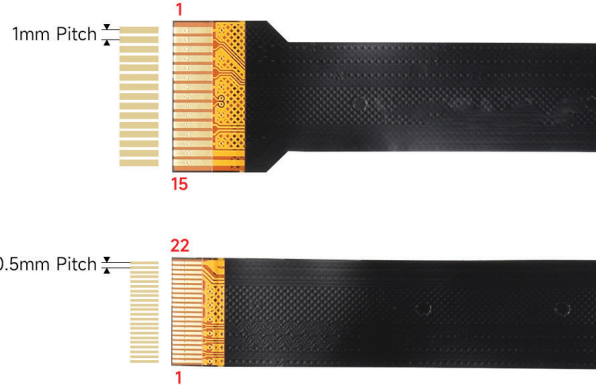

Çok Damarlı

100m

500m

10 Renk

0,75 mm NYAF Kablo



**0,80 mm NYA
Kablo**



Kablo Kanalları

DELİKLİ KABLO KANALLARI

FİYAT: SORUNUZ

24 x 40 mm
25 x 60 mm
40 x 40 mm
40 x 60 mm
60 x 60 mm
60 x 80 mm

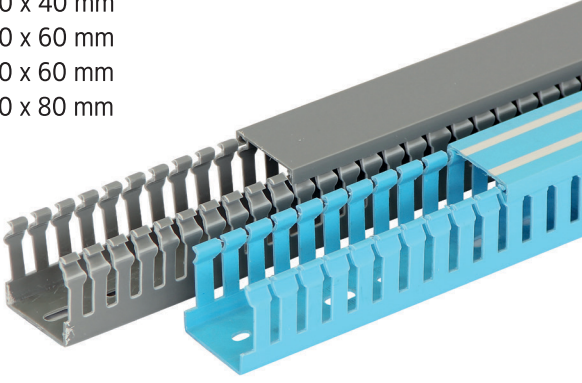

KAPALI KABLO KANALLARI

FİYAT: SORUNUZ

16 x 16 mm
25 x 16 mm
25 x 25 mm
40 x 60 mm
60 x 40 mm
10 x 40 mm
100 x 60 mm



SAÇ KABLO KANALLARI

FİYAT: SORUNUZ

50 x 40 mm
100 x 40 mm
100 x 60 mm



KANAL KROŞESİ

FİYAT: SORUNUZ

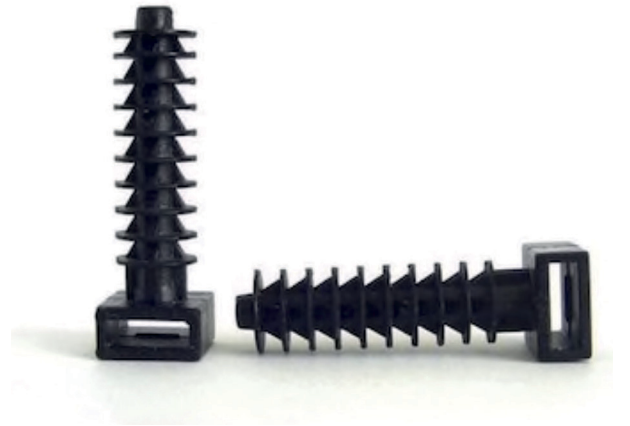

Aydınlatma Grubu

ELX-LED-5-SNB

5W Hareketli Spot Armatür

FİYAT SORUNUZ



5 W Saten Nikel Gövde
Beyaz Işık, Hareketli Spot

ELX-LTFA

T5 Anahtarlı Led Bant Armatür **KABLOLU**

FİYAT SORUNUZ



AÇIKLAMA	FİYAT
6 W Anahtarlı Led Lamba	Fiyat Sorunuz
10 W Anahtarlı Led Lamba	Fiyat Sorunuz
12 W Anahtarlı Led Lamba	Fiyat Sorunuz
16 W Anahtarlı Led Lamba	Fiyat Sorunuz

ELX-LTFA

Ledli Yatay Bant Armatür

FİYAT SORUNUZ



AÇIKLAMA	FİYAT
18 W Yatay Led Lamba	Fiyat Sorunuz
36 W Yatay Led Lamba	Fiyat Sorunuz

LED ŞERİT ve HORTUM AYDINLATMA

FİYAT SORUNUZ



Asansör Grubu Malzemeleri

PANO SİRALI

1-2-3-4 No

FİYAT: SORUNUZ



Hoparlör

FİYAT SORUNUZ



PLASTİK SİRAL

14-18 mm

FİYAT: SORUNUZ



KLEMENS

7 Delikli Topraklama Klemensi

FİYAT: 41. Sayfa



FAN FİLTRESİ - FAN TELİ İKLİMLENDİRME ÜRÜNLERİ

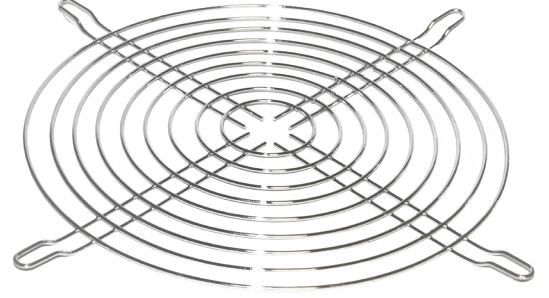

Turbo Fanlar

Gövdesi yüksek ısı uygulamaları için özel olarak ısıya dayanıklı yüksek kalite galvanize çelik sacdan, fanı alüminyumdan üretilmiştir.



Isı ile Daralan Renkli Makaronlar



120x120x38 Axial Metal Kare Fan



BELGELERİMİZ



* Bu fiyat listesi Ocak 2025 tarihinden itibaren geçerlidir.

* Fiyatlarımızda herhangi bir gerekeç göstermesizin değişiklik yapma hakkımız mahfuzdur.

* Faturalamada teslim tarihindeki liste fiyatları geçerlidir.

* Tipografik hatalardan firmamız sorumlu değildir.

* Siparişlerinizde stok sorunuz.

* Fiyatlarımız KDV dahil değildir.

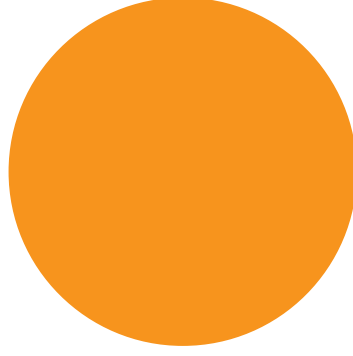

since 1943

el-max

Konya Elmak Elektrik Tic. ve San. A.Ş.

Büsan Organize Sanayi Sitesi 10723 Sokak

No:10 P.K. 42050

Karatay/KONYA

Tel : 0 332 345 18 11

Fax : 0 332 345 18 14



Konya Bölge : 0 530 406 44 59

0 530 602 59 50

0 530 602 63 74

İç Anadolu Bölge : 0 530 406 44 58

Akdeniz Bölge : 0 530 602 59 50

Ege Bölge : 0 530 291 08 42

G. Doğu Bölge : 0 530 291 08 42

Ankara Home Office : 0 530 291 08 42

www.el-max.com.tr